

For more information, visit www.desatech.com

VN600BA, VP600BA
VN1000BTA, VP1000BTA
VN10A, VP10A
VN10TA, VP10TA
VN6D, VP5D

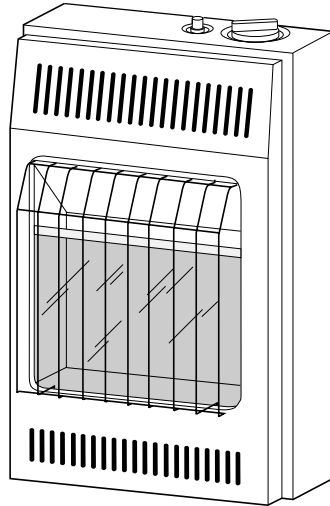

WARNING: If the information in this manual is not followed exactly, a fire or explosion may result causing property damage, personal injury, or loss of life.

- Do not store or use gasoline or other flammable vapors and liquids in the vicinity of this or any other appliance.
- **WHAT TO DO IF YOU SMELL GAS**
 - Do not try to light any appliance.
 - Do not touch any electrical switch; do not use any phone in your building.
 - Immediately call your gas supplier from a neighbor's phone. Follow the gas supplier's instructions.
 - If you cannot reach your gas supplier, call the fire department.
- Installation and service must be performed by a qualified installer, service agency, or the gas supplier.

WARNING: Improper installation, adjustment, alteration, service, or maintenance can cause injury or property damage. Refer to this manual for correct installation and operational procedures. For assistance or additional information consult a qualified installer, service agency, or the gas supplier.

WARNING: This is an unvented gas-fired heater. It uses air (oxygen) from the room in which it is installed. Provisions for adequate combustion and ventilation air must be provided. Refer to *Air For Combustion and Ventilation* on page 4 of this manual.

This appliance may be installed in an aftermarket*, permanently located, manufactured (mobile) home, where not prohibited by local codes.

This appliance is only for use with the type of gas indicated on the rating plate. This appliance is not convertible for use with other gases.

*Aftermarket: Completion of sale, not for purpose of resale, from the manufacturer

TABLE OF CONTENTS

SAFETY INFORMATION	2	SPECIFICATIONS	19
UNPACKING	3	ILLUSTRATED PARTS BREAKDOWN AND PARTS LIST	20
PRODUCT IDENTIFICATION	3	REPLACEMENT PARTS	30
PRODUCT FEATURES	3	SERVICE HINTS	30
LOCAL CODES	3	TECHNICAL SERVICE	30
AIR FOR COMBUSTION AND VENTILATION	4	SERVICE PUBLICATIONS	30
INSTALLATION	6	ACCESSORY	30
OPERATING HEATER	10	OWNER'S REGISTRATION FORM	31
INSPECTING BURNER	14	PARTS CENTRALS	33
CLEANING AND MAINTENANCE	15	WARRANTY INFORMATION	Back Cover
TROUBLESHOOTING	16		

SAFETY INFORMATION

WARNINGS

IMPORTANT: Read this owner's manual carefully and completely before trying to assemble, operate, or service this heater. Improper use of this heater can cause serious injury or death from burns, fire, explosion, electrical shock, and carbon monoxide poisoning.

 DANGER: Carbon monoxide poisoning may lead to death!

Carbon Monoxide Poisoning: Early signs of carbon monoxide poisoning resemble the flu, with headaches, dizziness, or nausea. If you have these signs, the heater may not be working properly. **Get fresh air at once!** Have heater serviced. Some people are more affected by carbon monoxide than others. These include pregnant women, persons with heart or lung disease or anemia, those under the influence of alcohol, and those at high altitudes.

Natural and Propane/LP Gas: Natural and propane/LP gases are fuel gases. Fuel gases are odorless. An odor-making agent is added to fuel gases. The odor helps you detect a fuel gas leak. However, the odor added to fuel gas can fade. Fuel gas may be present even though no odor exists.

Make certain you read and understand all warnings. Keep this manual for reference. It is your guide to safe and proper operation of this heater.

 WARNING: Any change to this heater or its controls can be dangerous.

 WARNING: Do not use any accessory not approved for use with this heater.

Due to high temperatures, the appliance should be located out of traffic and away from furniture and draperies.

Do not place clothing or other flammable material on or near the appliance. Never place any objects on the heater.

Surface of heater becomes very hot when running heater. Keep children and adults away from hot surface to avoid burns or clothing ignition. Heater will remain hot for a time after shutdown. Allow surface to cool before touching.

Carefully supervise young children when they are in the same room with heater.

Make sure grill guard is in place before running heater.

Keep the appliance area clear and free from combustible materials, gasoline, and other flammable vapors and liquids.

1. This appliance is only for use with the type of gas indicated on the rating plate. This appliance is not convertible for use with other gases.
2. Do not place propane/LP supply tank(s) inside any structure. Locate propane/LP supply tank(s) outdoors.
3. Do not install 10,000 Btu units in a bathroom.

SAFETY INFORMATION

Continued

4. If you smell gas
 - Shut off gas supply
 - Do not try to light any appliance
 - Do not touch any electrical switch; do not use any phone in your building
 - Immediately call your gas supplier from a neighbor's phone. Follow the gas supplier's instructions
 - If you cannot reach your gas supplier, call the fire department
5. This heater needs fresh, outside air ventilation to run properly. This heater has an Oxygen Depletion Sensing (ODS) safety shutoff system. The ODS shuts down the heater if not enough fresh air is available. See *Air for Combustion and Ventilation*, pages 4 through 6.
6. Always run heater with control knob at LOW or HIGH locked positions (VP10A) or ON position (VP5D). Never set control knob between locked positions. Poor combustion may result.
7. Keep all air openings in the front and bottom of heater clear and free of debris. This will insure enough air for proper combustion.
8. If heater shuts off, do not relight until you provide fresh, outside air. If heater keeps shutting off, have it serviced.
9. Do not run heater
 - where flammable liquids or vapors are used or stored
 - under dusty conditions
10. Before using furniture polish, wax, carpet cleaner, or similar products, turn heater off. If heated, the vapors from these products may create a white powder residue within burner box or on adjacent walls or furniture.
11. Do not use heater if any part has been under water. Immediately call a qualified service technician to inspect the room heater and to replace any part of the control system and any gas control which has been under water.
12. Turn off heater and let cool before servicing. Only a qualified service person should service and repair heater.
13. Operating heater above elevations of 4,500 feet could cause pilot outage.
14. To prevent performance problems, do not use propane/LP fuel tank of less than 100 lbs. capacity.
15. Provide adequate clearances around air openings.

UNPACKING

1. Remove heater from carton.
2. Remove all protective packaging applied to heater for shipment.
3. Check heater for any shipping damage. If heater is damaged, promptly inform dealer where you bought heater.

PRODUCT IDENTIFICATION

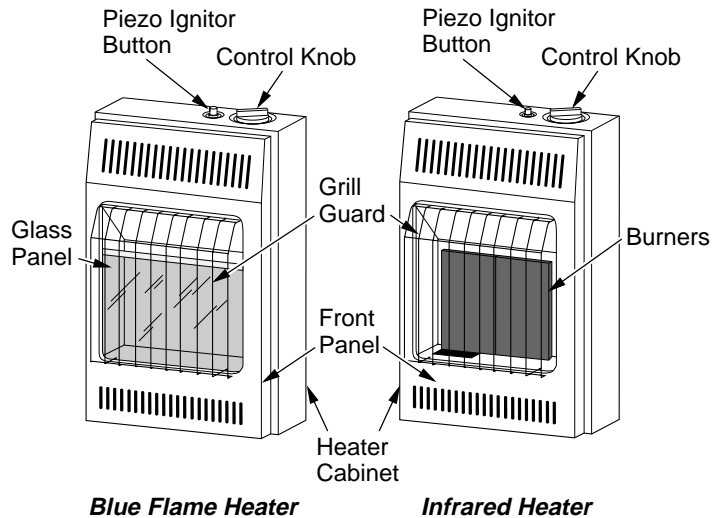

Figure 1 - Vent-Free Gas Heater

PRODUCT FEATURES

SAFETY DEVICE

This heater has a pilot with an Oxygen Depletion Sensing (ODS) safety shutoff system. The ODS/pilot is a required feature for vent-free room heaters. The ODS/pilot shuts off the heater if there is not enough fresh air.

PIEZO IGNITION SYSTEM

This heater has a piezo ignitor. This system requires no matches, batteries, or other sources to light heater.

LOCAL CODES

Install and use heater with care. Follow all local codes. In the absence of local codes, use the latest edition of *National Fuel Gas Code ANSI Z223.1/NFPA 54**.

*Available from:

American National Standards Institute, Inc.
1430 Broadway
New York, NY 10018

National Fire Protection Association, Inc.
Batterymarch Park
Quincy, MA 02269

AIR FOR COMBUSTION AND VENTILATION

⚠ WARNING: This heater shall not be installed in a confined space or unusually tight construction unless provisions are provided for adequate combustion and ventilation air. Read the following instructions to insure proper fresh air for this and other fuel-burning appliances in your home.

Today's homes are built more energy efficient than ever. New materials, increased insulation, and new construction methods help reduce heat loss in homes. Home owners weather strip and caulk around windows and doors to keep the cold air out and the warm air in. During heating months, home owners want their homes as airtight as possible.

While it is good to make your home energy efficient, your home needs to breathe. Fresh air must enter your home. All fuel-burning appliances need fresh air for proper combustion and ventilation.

Exhaust fans, fireplaces, clothes dryers, and fuel burning appliances draw air from the house to operate. You must provide adequate fresh air for these appliances. This will insure proper venting of vented fuel-burning appliances.

PROVIDING ADEQUATE VENTILATION

The following are excerpts from *National Fuel Gas Code, ANSI Z223.1/NFPA 54, Section 5.3, Air for Combustion and Ventilation*.

All spaces in homes fall into one of the three following ventilation classifications:

1. Unusually Tight Construction
2. Unconfined Space
3. Confined Space

The information on pages 4 through 6 will help you classify your space and provide adequate ventilation.

Unusually Tight Construction

The air that leaks around doors and windows may provide enough fresh air for combustion and ventilation. However, in buildings of unusually tight construction, you must provide additional fresh air.

Unusually tight construction is defined as construction where:

- a. walls and ceilings exposed to the outside atmosphere have a continuous water vapor retarder with a rating of one perm (6×10^{-11} kg per pa-sec- m^2) or less with openings gasketed or sealed and
- b. weather stripping has been added on openable windows and doors and

- c. caulking or sealants are applied to areas such as joints around window and door frames, between sole plates and floors, between wall-ceiling joints, between wall panels, at penetrations for plumbing, electrical, and gas lines, and at other openings.

If your home meets all of the three criteria above, you must provide additional fresh air. See *Ventilation Air From Outdoors*, page 6.

If your home does not meet all of the three criteria above, proceed to *Determining Fresh-Air Flow For Heater Location*, page 5.

Confined and Unconfined Space

The *National Fuel Gas Code, ANSI Z223.1/NFPA 54* defines a confined space as a space whose volume is less than 50 cubic feet per 1,000 Btu per hour (4.8 m^3 per kw) of the aggregate input rating of all appliances installed in that space and an unconfined space as a space whose volume is not less than 50 cubic feet per 1,000 Btu per hour (4.8 m^3 per kw) of the aggregate input rating of all appliances installed in that space. Rooms communicating directly with the space in which the appliances are installed*, through openings not furnished with doors, are considered a part of the unconfined space.

* Adjoining rooms are communicating only if there are doorless passageways or ventilation grills between them.

DETERMINING FRESH-AIR FLOW FOR HEATER LOCATION

Determining if You Have a Confined or Unconfined Space

Use this work sheet to determine if you have a confined or unconfined space.

Space: Includes the room in which you will install heater plus any adjoining rooms with doorless passageways or ventilation grills between the rooms.

1. Determine the volume of the space (length x width x height).
 $\text{Length} \times \text{Width} \times \text{Height} = \underline{\hspace{2cm}} \text{ cu. ft. (volume of space)}$
Example: Space size 22 ft. (length) x 18 ft. (width) x 8 ft. (ceiling height) = 3168 cu. ft. (volume of space)
 If additional ventilation to adjoining room is supplied with grills or openings, add the volume of these rooms to the total volume of the space.
2. Multiply the space volume by 20 to determine the maximum Btu/Hr the space can support.
 $\underline{\hspace{2cm}} \text{ (volume of space)} \times 20 = \text{(Maximum Btu/Hr the space can support)}$
Example: 2560 cu. ft. (volume of space) x 20 = 51,200 (maximum Btu/Hr the space can support)

AIR FOR COMBUSTION AND VENTILATION

Continued

3. Add the Btu/Hr of all fuel burning appliances in the space.

Vent-free heater	_____	Btu/Hr
Gas water heater*	_____	Btu/Hr
Gas furnace	_____	Btu/Hr
Vented gas heater	_____	Btu/Hr
Gas fireplace logs	_____	Btu/Hr
Other gas appliances* +	_____	Btu/Hr
Total	= _____	Btu/Hr

* Do not include direct-vent gas appliances. Direct-vent draws combustion air from the outdoors and vents to the outdoors.

Example:

Gas water heater	_____	40,000	Btu/Hr
Vent-free heater	+ _____	10,000	Btu/Hr
Total	= _____	50,000	Btu/Hr

4. Compare the maximum Btu/Hr the space can support with the actual amount of Btu/Hr used.

_____ Btu/Hr (maximum the space can support)
 _____ Btu/Hr (actual amount of Btu/Hr used)

Example: 51,200 Btu/Hr (maximum the space can support)
 50,000 Btu/Hr (actual amount of Btu/Hr used)

The space in the above example is a confined space because the actual Btu/Hr used is more than the maximum Btu/Hr the space can support. You must provide additional fresh air. Your options are as follows:

- A. Rework worksheet, adding the space of an adjoining room. If the extra space provides an unconfined space, remove door to adjoining room or add ventilation grills between rooms. See *Ventilation Air From Inside Building*.
- B. Vent room directly to the outdoors. See *Ventilation Air From Outdoors*.
- C. Install a lower Btu/Hr heater, if lower Btu/Hr size makes room unconfined.

If the actual Btu/Hr used is less than the maximum Btu/Hr the space can support, the space is an unconfined space. You will need no additional fresh air ventilation.

⚠ WARNING: If the area in which the heater may be operated is smaller than that defined as an unconfined space or if the building is of unusually tight construction, provide adequate combustion and ventilation air by one of the methods described in the *National Fuel Gas Code, ANSI Z223.1/NFPA 54, Section 5.3* or applicable local codes.

VENTILATION AIR

Ventilation Air From Inside Building

This fresh air would come from an adjoining unconfined space. When ventilating to an adjoining unconfined space, you must provide two permanent openings: one within 12" of the ceiling and one within 12" of the floor on the wall connecting the two spaces (see options 1 and 2, Figure 2). You can also remove door into adjoining room (see option 3, Figure 2). Follow the *National Fuel Gas Code, ANSI Z223.1/NFPA 54, Section 5.3, Air for Combustion and Ventilation* for required size of ventilation grills or ducts.

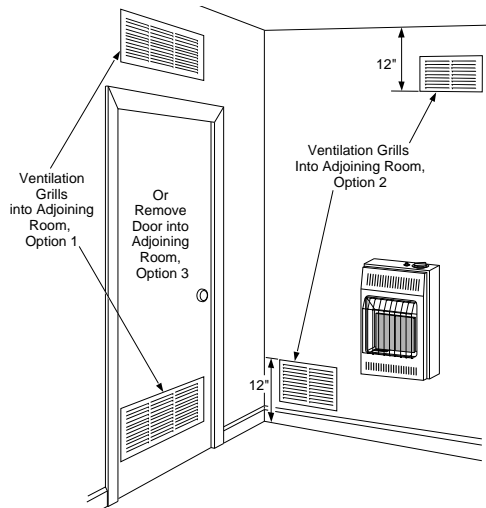

Figure 2 - Ventilation Air from Inside Building

Ventilation Air From Outdoors

Provide extra fresh air by using ventilation grills or ducts. You must provide two permanent openings: one within 12" of the ceiling and one within 12" of the floor. Connect these items directly to the outdoors or spaces open to the outdoors. These spaces include attics and crawl spaces. Follow the *National Fuel Gas Code, ANSI Z223.1/NFPA 54, Section 5.3, Air for Combustion and Ventilation* for required size of ventilation grills or ducts.

IMPORTANT: Do not provide openings for inlet or outlet air into attic if attic has a thermostat-controlled power vent. Heated air entering the attic will activate the power vent.

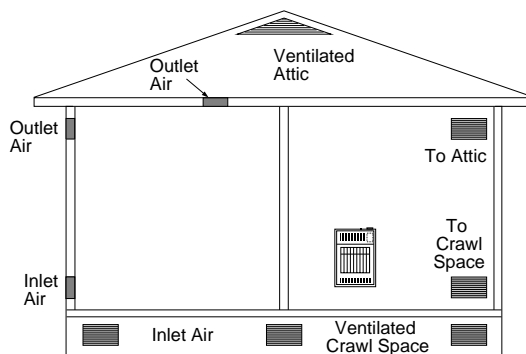

Figure 3 - Ventilation Air from Outdoors

INSTALLATION

NOTICE: This heater is intended for use as supplemental heat. Use this heater along with your primary heating system. Do not install this heater as your primary heat source. If you have a central heating system, you may run system's circulating blower while using heater. This will help circulate the heat throughout the house. In the event of a power outage, you can use this heater as your primary heat source.

WARNING: A qualified service person must install heater. Follow all local codes.

CHECK GAS TYPE

Use only the correct type of gas (natural or propane/LP). If your gas supply is not the correct gas type, do not install heater. Call dealer where you bought heater for proper type heater.

INSTALLATION ITEMS

Before installing heater, make sure you have the items listed below.

- for propane/LP gas, external regulator (supplied by installer)
- piping (check local codes)
- sealant (resistant to propane/LP gas)
- equipment shutoff valve *
- ground joint union
- sediment trap
- tee joint
- pipe wrench
- for natural gas, test gauge connection*

* A CSA design-certified equipment shutoff valve with 1/8" NPT tap is an acceptable alternative to test gauge connection. Purchase the optional CSA design-certified equipment shutoff valve from your dealer. See *Accessory*, page 30.

LOCATING HEATER

This heater is designed to be mounted on a wall.

WARNING: Maintain the minimum clearances shown in Figure 4. If you can, provide greater clearances from floor, ceiling, and joining wall.

- WARNING:** Never install the heater
- in a bathroom (10,000 Btu/hr only. 6,000 Btu/hr models are allowed in a bathroom. Check local codes.)
 - in a recreational vehicle
 - where curtains, furniture, clothing, or other flammable objects are less than 36 inches from the front, top, or sides of the heater
 - as a fireplace insert
 - in high traffic areas
 - in windy or drafty areas

CAUTION: This heater creates warm air currents. These currents move heat to wall surfaces next to heater. Installing heater next to vinyl or cloth wall coverings or operating heater where impurities (such as, but not limited to, tobacco smoke, aromatic candles, cleaning fluids, oil or kerosene lamps, etc.) in the air exist, may discolor walls or cause odors.

IMPORTANT: Vent-free heaters add moisture to the air. Although this is beneficial, installing heater in rooms without enough ventilation air may cause mildew to form from too much moisture. See *Air for Combustion and Ventilation*, pages 4 through 6.

- CAUTION:** If you install the heater in a home garage
- heater pilot and burner must be at least 18 inches above floor
 - locate heater where moving vehicle will not hit it

For convenience and efficiency, install heater

- where there is easy access for operation, inspection, and service
- in coldest part of room

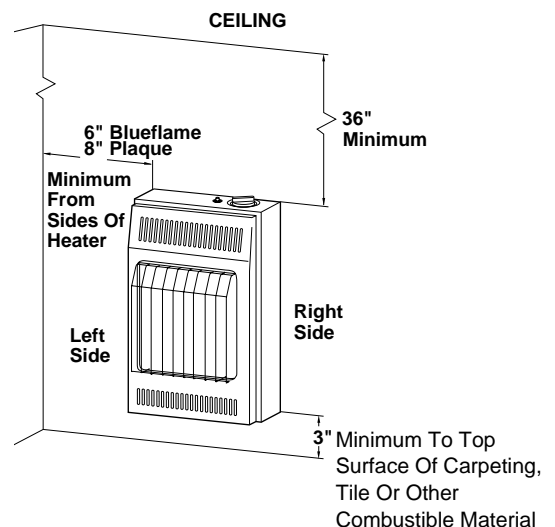

Figure 4 - Mounting Clearances As Viewed From Front of Heater

INSTALLATION

Continued

THERMOSTAT SENSING BULB (Thermostat Models Only)

The thermostat sensing bulb is located inside the heater. Do not move this bulb during installation or operation of the heater.

INSTALLING HEATER TO WALL

Marking Screw Locations

1. Determine where you will locate heater.

⚠ WARNING: Maintain minimum clearances shown in Figure 5. If you can, provide greater clearances from floor and joining wall.

2. Mark two mounting screw locations on wall (see Figure 5).

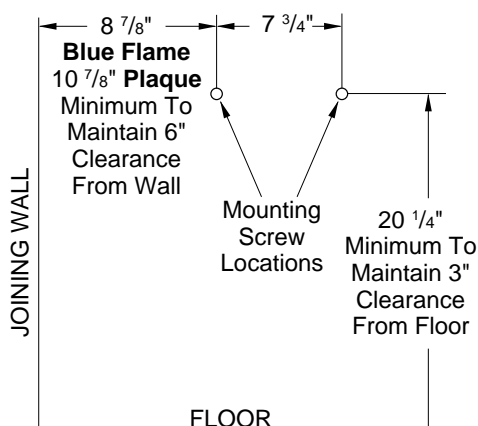

Figure 5 - Mounting Screw Locations

Installing Two Mounting Screws

Note: Wall anchors and mounting screws are in hardware package. The hardware package is provided with heater.

Attaching to wall stud method

For attaching mounting screw to wall stud

1. Drill hole at marked location using 9/64" drill bit.
2. Insert mounting screw into wall stud.
3. Tighten screw until 1/16" space (thickness of penny) is between screwhead and wall.

Attaching to wall anchor method

Follow instructions below to attach mounting screws to hollow walls (wall areas between studs) or solid walls (concrete or masonry).

1. Drill holes at marked locations using 5/16" drill bit. For solid walls (concrete or masonry), drill at least 1 1/4" deep.
2. Fold wall anchor (see Figure 6).
3. Insert wall anchor (wings first) into hole. Tap anchor flush to wall.

4. For thin walls (1/2" or less), insert red key into wall anchor. Push red key to "pop" open anchor wings (see Figure 7). **IMPORTANT:** Do not hammer key! For thick walls (over 1/2" thick) or solid walls, do not pop open wings.
5. Tighten two screws until 1/16" space (thickness of penny) is between screwheads and wall (see Figure 8).

Thin Walls (1/4" to 1/2" thick)

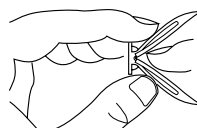

Figure 6 - Folding Anchor

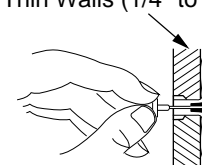

Figure 7 - Popping Open Anchor Wings For Thin Walls

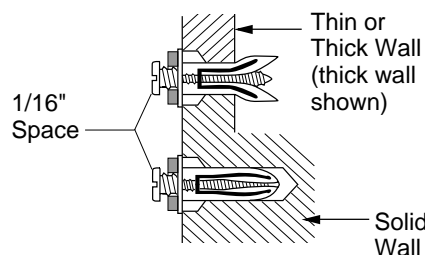

Figure 8 - Tightening Anchors

Placing Heater On Mounting Screws

1. Locate two keyhole slots on back panel of heater (see Figure 9).
2. Place large openings of slots over screwheads. Slide heater down until screws are in small portion of slots.

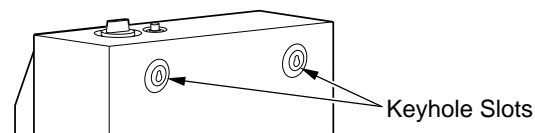

Figure 9 - Location Of Keyhole Slots On Back Panel Of Heater

Removing Front Panel Of Heater

1. Remove two screws near bottom corners of front panel.
2. Lift straight up on grill guard until it stops. Grill guard will slide up about 1/4".
3. Pull bottom of front panel forward, then down.

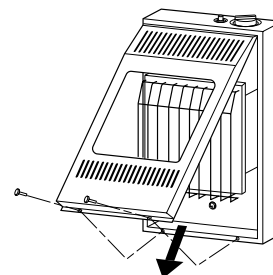

Figure 10 - Removing Front Panel Of Heater

INSTALLATION

Continued

Installing Bottom Mounting Screw

1. Locate bottom mounting hole. This hole is near bottom on back panel of heater (see Figure 11).
2. Mark screw location on wall.
3. Remove heater from wall.
4. If installing bottom mounting screw into hollow or solid wall, install wall anchor. Follow steps 1 through 5 under *Attaching To Wall Anchor Method*, page 7. If installing bottom mounting screw into wall stud, drill hole at marked location using 9/64" drill bit.
5. Replace heater on wall.
6. Insert bottom anchor screw through back panel into bottom anchor or drilled hole (see Figure 11).
7. Tighten screw until heater is firmly secured to wall. Do not over tighten.

Note: Do not replace front panel at this time. Replace front panel after making gas connections and checking for leaks (see pages 8 through 10).

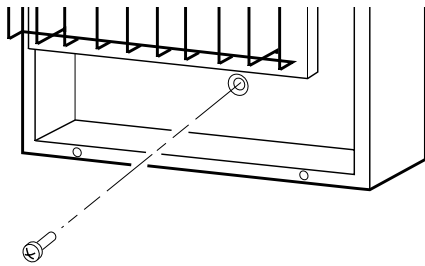

Figure 11 - Installing Bottom Mounting Screw

CONNECTING TO GAS SUPPLY

WARNING: This appliance requires a 3/8" NPT (National Pipe Thread) inlet connection to the pressure regulator.

WARNING: A qualified service person must connect heater to gas supply. Follow all local codes.

WARNING: For natural gas, never connect heater to private (non-utility) gas wells. This gas is commonly known as wellhead gas.

IMPORTANT: For natural gas, check gas line pressure before connecting heater to gas line. Gas line pressure must be no greater than 14 inches of water. If gas line pressure is higher, heater regulator damage could occur.

CAUTION: For propane/LP gas, never connect heater directly to the propane/LP supply. This heater requires an external regulator (not supplied). Install the external regulator between the heater and propane/LP supply.

For propane/LP gas, the installer must supply an external regulator. The external regulator will reduce incoming gas pressure. You must reduce incoming gas pressure to between 11 and 14 inches of water. If you do not reduce incoming gas pressure, heater regulator damage could occur. Install external regulator with the vent pointing down as shown in Figure 12. Pointing the vent down protects it from freezing rain or sleet.

CAUTION: Use only new, black iron or steel pipe. Internally-tinned copper tubing may be used in certain areas. Check your local codes. Use pipe of large enough diameter to allow proper gas volume to heater. If pipe is too small, undue loss of volume will occur.

Installation must include equipment shutoff valve, union, and plugged 1/8" NPT tap. Locate NPT tap within reach for test gauge hook up. NPT tap must be upstream from heater (see Figure 13, page 9).

IMPORTANT: Install an equipment shutoff valve in an accessible location. The equipment shutoff valve is for turning on or shutting off the gas to the appliance.

Check your building codes for any special requirements for locating equipment shutoff valve to fireplaces.

Apply pipe joint sealant lightly to male NPT threads. This will prevent excess sealant from going into pipe. Excess sealant in pipe could result in clogged heater valves.

WARNING: Use pipe joint sealant that is resistant to liquid petroleum (LP) gas.

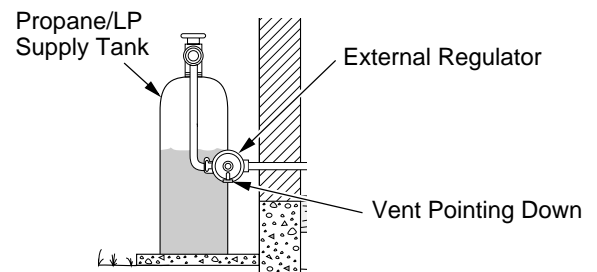

Figure 12 - External Regulator With Vent Pointing Down (propane/LP systems only)

INSTALLATION

Continued

We recommend that you install sediment trap in supply line as shown in Figure 13. Locate sediment trap where it is within reach for cleaning. Install in piping system between fuel supply and heater. Locate sediment trap where trapped matter is not likely to freeze. A sediment trap traps moisture and contaminants. This keeps them from going into heater controls. If sediment trap is not installed or is installed wrong, heater may not run properly.

IMPORTANT: Hold pressure regulator with wrench when connecting it to gas piping and/or fittings. Do not over tighten pipe connection to regulator. The regulator body could be damaged.

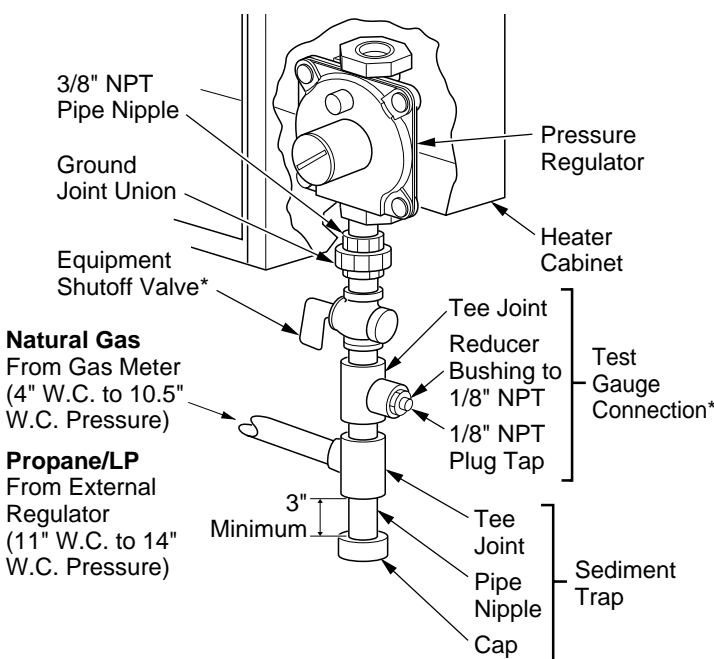

Figure 13 - Gas Connection

* A CSA design-certified equipment shutoff valve with 1/8" NPT tap is an acceptable alternative to test gauge connection. Purchase the optional CSA design-certified equipment shutoff valve from your dealer. See *Accessory*, page 30.

CHECKING GAS CONNECTIONS

WARNING: Test all gas piping and connections for leaks after installing or servicing. Correct all leaks at once.

WARNING: Never use an open flame to check for a leak. Apply a noncorrosive leak detection fluid to all joints. Bubbles forming show a leak. Correct all leaks at once.

CAUTION: For propane/LP gas, make sure external regulator has been installed between propane/LP supply and heater. See guidelines under *Connecting to Gas Supply*, page 8.

Pressure Testing Gas Supply Piping System

Test Pressures In Excess Of 1/2 PSIG (3.5 kPa)

1. Disconnect appliance with its appliance main gas valve (control valve) and equipment shutoff valve from gas supply piping system. Pressures in excess of 1/2 psig will damage heater regulator.
2. Cap off open end of gas pipe where equipment shutoff valve was connected.
3. Pressurize supply piping system by either opening propane/LP supply tank valve for propane/LP gas or opening main gas valve located on or near gas meter for natural gas, or using compressed air.
4. Check all joints of gas supply piping system. Apply a non-corrosive leak detection fluid to all joints. Bubbles forming show a leak.
5. Correct all leaks at once.
6. Reconnect heater and equipment shutoff valve to gas supply. Check reconnected fittings for leaks.

Test Pressures Equal To or Less Than 1/2 PSIG (3.5 kPa)

1. Close equipment shutoff valve (see Figure 14).
2. Pressurize supply piping system by either opening propane/LP supply tank valve for propane/LP gas or opening main gas valve located on or near gas meter for natural gas, or using compressed air.

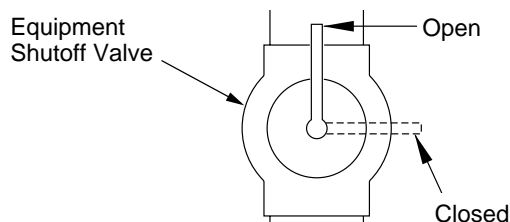

Figure 14 - Equipment Shutoff Valve

INSTALLATION

Continued

3. Check all joints from gas meter for natural or propane/LP supply to equipment shutoff valve (see Figure 17 or 18). Apply a noncorrosive leak detection fluid to all joints. Bubbles forming show a leak.
4. Correct all leaks at once.

Pressure Testing Heater Gas Connections

1. Open equipment shutoff valve (see Figure 14, page 9).
2. Open main gas valve located on or near gas meter for natural gas or open propane/LP supply tank valve.
3. Make sure control knob of heater is in the OFF position.
4. Check all joints from equipment shutoff valve to control valve (see Figures 15 and 16). Apply a noncorrosive leak detection fluid to all joints. Bubbles forming show a leak.
5. Correct all leaks at once.
6. Light heater (see *Operating Heater* pages 10 through 14). Check the rest of the internal joints for leaks.
7. Turn off heater (see *To Turn Off Gas to Appliance*, pages 11, 12 or 14, depending on your model).
8. Replace front panel.

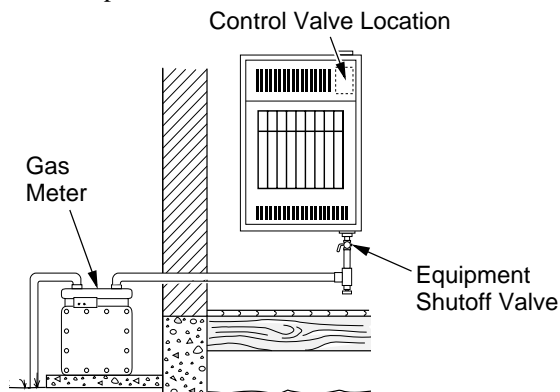

Figure 15 - Checking Gas Joints for Natural Gas

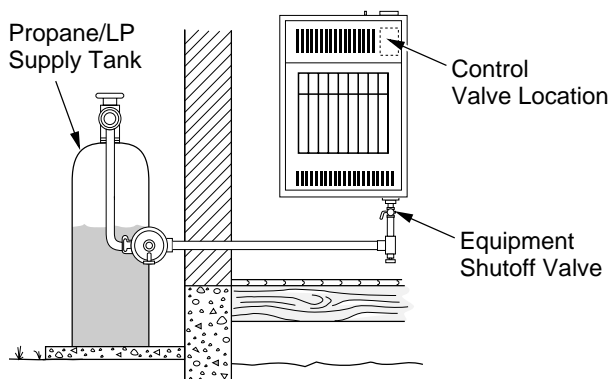

Figure 16 - Checking Gas Joints for Propane/LP Gas

OPERATING HEATER



MANUAL CONTROL BLUE FLAME MODELS

FOR YOUR SAFETY READ BEFORE LIGHTING

⚠ WARNING: If you do not follow these instructions exactly, a fire or explosion may result causing property damage, personal injury or loss of life.

- A. This appliance has a pilot which must be lighted by hand. When lighting the pilot, follow these instructions exactly.
- B. **BEFORE LIGHTING** smell all around the appliance area for gas. Be sure to smell next to the floor because some gas is heavier than air and will settle on the floor.
WHAT TO DO IF YOU SMELL GAS
 - Do not try to light any appliance.
 - Do not touch any electric switch; do not use any phone in your building.
 - Immediately call your gas supplier from a neighbor's phone. Follow the gas supplier's instructions.
 - If you cannot reach your gas supplier, call the fire department.
- C. Use only your hand to push in or turn the gas control knob. Never use tools. If the knob will not push in or turn by hand, don't try to repair it, call a qualified service technician or gas supplier. Force or attempted repair may result in a fire or explosion.
- D. Do not use this appliance if any part has been under water. Immediately call a qualified service technician to inspect the appliance and to replace any part of the control system and any gas control which has been under water.

LIGHTING INSTRUCTIONS

1. **STOP!** Read the safety information above.
2. Make sure equipment shutoff valve is fully open.
3. Turn control knob clockwise  to the OFF position.
4. Wait five (5) minutes to clear out any gas. Then smell for gas, including near the floor. If you smell gas, **STOP!** Follow "B" in the safety information, above. If you don't smell gas, go to the next step.
5. Press in control knob and turn counterclockwise  to the PILOT position. Keep control knob pressed in for five (5) seconds (see Figure 17, page 11).
Note: You may be running this heater for the first time after hooking up to gas supply. If so, the control knob may need to be pressed in for 30 seconds or more. This will allow air to bleed from the gas system.
 - If control knob does not pop up when released, contact a qualified service person or gas supplier for repairs.

OPERATING HEATER Continued

- With control knob pressed in, push down and release ignitor button. This will light pilot. The pilot is attached to the front of burner. If needed, keep pressing ignitor button until pilot lights.

Note: If pilot does not stay lit, refer to *Troubleshooting*, pages 16 through 18. Also contact a qualified service person or gas supplier for repairs. Until repairs are made, light pilot with match. To light pilot with match, see *Manual Lighting Procedure*.

- Keep control knob pressed in for 30 seconds after lighting pilot. After 30 seconds, release control knob.

Note: If pilot goes out, repeat steps 3 through 7.

- Turn control knob counterclockwise to the HIGH position. The main burner should light. Set control knob to any heat level between HIGH and LOW. To turn control knob from HIGH to a lower setting, press in the control knob and turn counterclockwise.

Note: Both HIGH and LOW are locked positions. You must press in control knob before turning it from these positions.

CAUTION: Do not try to adjust heating levels by using the equipment shutoff valve.

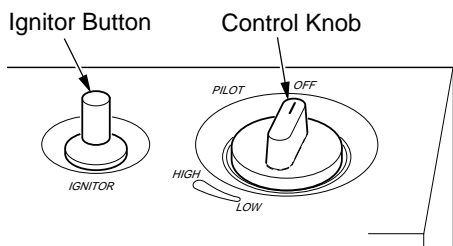

Figure 17 - Control Knob In The OFF Position

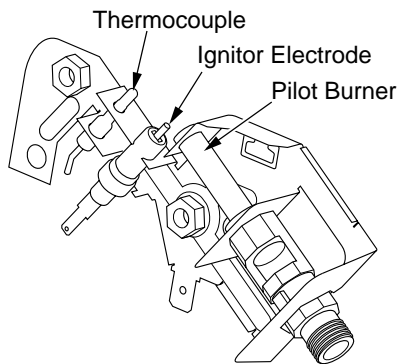

Figure 18 - Pilot

TO TURN OFF GAS TO APPLIANCE

Shutting Off Heater

- Turn control knob clockwise to the PILOT position.
- Press in control knob and turn clockwise to the OFF position.

Shutting Off Burner Only (pilot stays lit)

Turn control knob clockwise to the PILOT position.

MANUAL LIGHTING PROCEDURE

- Remove front panel (see Figure 10, page 7).
- Follow steps 1 through 5 under *Lighting Instructions*, page 10.
- With control knob pressed in, strike match. Hold match to pilot until pilot lights.
- Keep control knob pressed in for 30 seconds after pilot is lit. After 30 seconds, release control knob. Follow step 8 under *Lighting Instructions*.
- Replace front panel.

MANUAL CONTROL INFRARED MODELS

FOR YOUR SAFETY READ BEFORE LIGHTING

WARNING: If you do not follow these instructions exactly, a fire or explosion may result causing property damage, personal injury or loss of life.

- This appliance has a pilot which must be lighted by hand. When lighting the pilot, follow these instructions exactly.
- BEFORE LIGHTING** smell all around the appliance area for gas. Be sure to smell next to the floor because some gas is heavier than air and will settle on the floor.

WHAT TO DO IF YOU SMELL GAS



- Do not try to light any appliance.
- Do not touch any electric switch; do not use any phone in your building.
- Immediately call your gas supplier from a neighbor's phone. Follow the gas supplier's instructions.
- If you cannot reach your gas supplier, call the fire department.

OPERATING HEATER

Continued

- C. Use only your hand to push in or turn the gas control knob. Never use tools. If the knob will not push in or turn by hand, don't try to repair it, call a qualified service technician or gas supplier. Force or attempted repair may result in a fire or explosion.
- D. Do not use this appliance if any part has been under water. Immediately call a qualified service technician to inspect the appliance and to replace any part of the control system and any gas control which has been under water.

LIGHTING INSTRUCTIONS

1. STOP! Read the safety information page 11, column 2.
2. Make sure equipment shutoff valve is fully open.
3. Turn control knob clockwise  to the OFF position.
4. Wait five (5) minutes to clear out any gas. Then smell for gas, including near the floor. If you smell gas, STOP! Follow "B" in the safety information, page 11, column 2. If you don't smell gas, go to the next step.
5. Press in control knob, and turn counterclockwise  to pilot position. Keep control knob pressed for five seconds.

Note: You may be running this heater for the first time after hooking up to gas supply. If so, the control knob may need to be pressed in for 30 seconds or more. This will allow air to bleed from the gas system.

- If control knob does not pop up when released, contact a qualified service person or gas supplier for repairs.

6. With control knob pressed in, push down and release ignitor button. This will light pilot. The pilot is attached to the front of burner. If needed, keep pressing ignitor button until pilot lights.

Note: If pilot does not light, refer to *Troubleshooting*, pages 17 through 19. Also contact a qualified service person or gas supplier for repairs. Until repairs are made, light pilot with match, see *Manual Lighting Procedure*, page 13.

7. Keep control knob pressed in for 10 seconds after lighting pilot. After 10 seconds, release control knob.

Note: If pilot goes out, repeat steps 3 through 7.

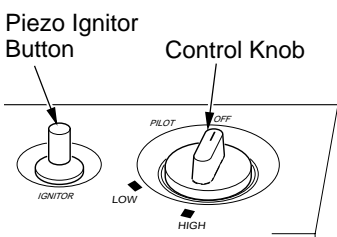

Figure 19 - Control Knob In The OFF Position

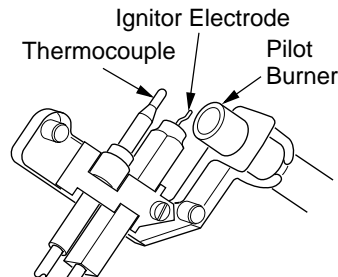



Figure 20 - Pilot, Infrared Heaters

TO SELECT HEATING LEVEL

WARNING: When running heater, set control knob at LOW or HIGH locked positions for double burner heater, or ON position for single burner heater.. Never set control knob between locked positions. Poor combustion and higher levels of carbon monoxide may result.

CAUTION: Do not try to adjust heating levels by using the equipment shutoff valve.

Slightly press in control knob and turn counterclockwise  to the LOW or HIGH positions for double burner heater, or ON position for single burner heater.

IMPORTANT: Release downward pressure while turning control knob. Control knob will lock at the desired position.

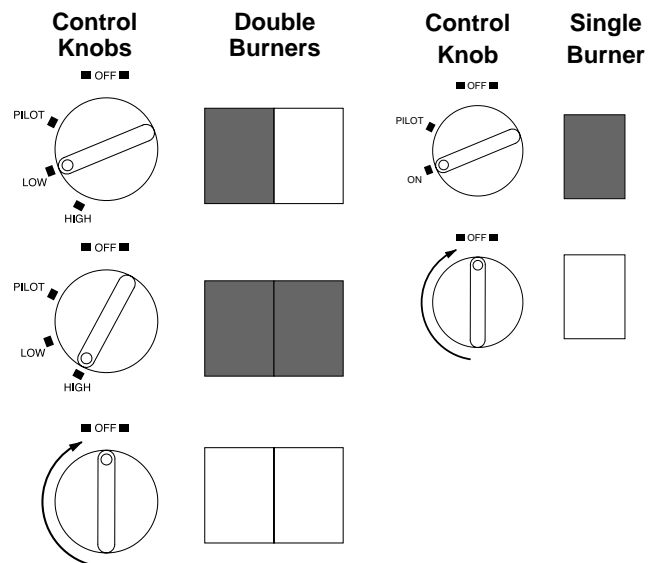

Figure 21 - Burner Patterns

TO TURN OFF GAS TO APPLIANCE

Shutting Off Heater

Turn control knob clockwise  to the OFF position.

Shutting Off Burner Only (pilot stays lit)

Turn control knob clockwise to the PILOT position.

OPERATING HEATER *Continued*

MANUAL LIGHTING PROCEDURE

1. Remove front panel (see Figure 10, page 7).
2. Follow steps 1 through 5 under *Lighting Instructions*, page 12.
3. With control knob pressed in, strike match. Hold match to pilot until pilot lights.
4. Keep control knob pressed in for 10 seconds after pilot is lit. After 10 seconds, release control knob.
5. Replace front panel.

THERMOSTAT CONTROL BLUE FLAME AND INFRARED MODELS



FOR YOUR SAFETY READ BEFORE LIGHTING

⚠ WARNING: If you do not follow these instructions exactly, a fire or explosion may result causing property damage, personal injury or loss of life.

- A. This appliance has a pilot which must be lighted by hand. When lighting the pilot, follow these instructions exactly.
- B. **BEFORE LIGHTING** smell all around the appliance area for gas. Be sure to smell next to the floor because some gas is heavier than air and will settle on the floor.
WHAT TO DO IF YOU SMELL GAS
 - Do not try to light any appliance.
 - Do not touch any electric switch; do not use any phone in your building.
 - Immediately call your gas supplier from a neighbor's phone. Follow the gas supplier's instructions.
 - If you cannot reach your gas supplier, call the fire department.
- C. Use only your hand to push in or turn the gas control knob. Never use tools. If the knob will not push in or turn by hand, don't try to repair it, call a qualified service technician or gas supplier. Force or attempted repair may result in a fire or explosion.
- D. Do not use this appliance if any part has been under water. Immediately call a qualified service technician to inspect the appliance and to replace any part of the control system and any gas control which has been under water.

LIGHTING INSTRUCTIONS

1. **STOP!** Read the safety information above.
2. Make sure equipment shutoff valve is fully open.

3. Turn control knob clockwise  to the OFF position (see Figure 22).
4. Wait five (5) minutes to clear out any gas. Then smell for gas, including near the floor. If you smell gas, **STOP!** Follow "B" in the safety information, column 1. If you don't smell gas, go to the next step.
5. Turn control knob counterclockwise  to the PILOT position. Press in control knob for five (5) seconds (see Figure 22).
Note: You may be running this heater for the first time after hooking up to gas supply. If so, the control knob may need to be pressed in for 30 seconds or more. This will allow air to bleed from the gas system.
6. With control knob pressed in, push down and release ignitor button. This will light pilot. The pilot is attached to the front of burner. The pilot can be seen through the glass panel. If needed, keep pressing ignitor button until pilot lights.
Note: If pilot does not stay lit, refer to *Troubleshooting*, pages 16 through 18. Also contact a qualified service person or gas supplier for repairs. Until repairs are made, light pilot with match. To light pilot with match, see *Manual Lighting Procedure*, page 14.
7. Keep control knob pressed in for 30 seconds after lighting pilot. After 30 seconds, release control knob.
 - If control knob does not pop up when released, contact a qualified service person or gas supplier for repairs.**Note:** If pilot goes out, repeat steps 3 through 7. This heater has a safety interlock system. Wait one (1) minute before lighting pilot again.
8. Turn control knob counterclockwise  to desired heating level. The main burner should light. Set control knob to any heat level between HI and LO.

⚠ CAUTION: Do not try to adjust heating levels by using the equipment shutoff valve.

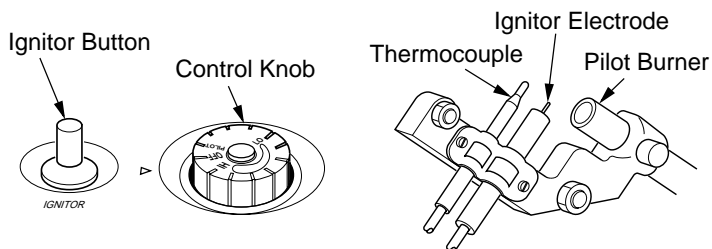

Figure 22 - Control Knob In The OFF Position

Figure 23 - Pilot (Infrared Heater Shown)

OPERATING HEATER

Continued

TO TURN OFF GAS TO APPLIANCE

Shutting Off Heater

1. Turn control knob clockwise  to the OFF position.
2. Turn off all electric power to the appliance if service is to be performed.

Shutting Off Burner Only (pilot stays lit)

Turn control knob clockwise  to the PILOT position.

THERMOSTAT CONTROL OPERATION

The thermostatic control used on these models differs from standard thermostats. Standard thermostats simply turn on and off the burner. The thermostat used on this heater senses the room temperature. The thermostat adjusts the amount of gas flow to the burner. This increases or decreases the burner flame height. At times the room may exceed the set temperature. If so, the burner will shut off. The burner will cycle back on when room temperature drops below the set temperature. The control knob can be set to any heat level between HI and LO.

Note: The thermostat sensing bulb measures the temperature of air near the heater cabinet. This may not always agree with room temperature (depending on housing construction, installation location, room size, open air temperatures, etc.). Frequent use of your heater will let you determine your own comfort levels.

MANUAL LIGHTING PROCEDURE

1. Remove front panel (see Figure 10, page 7).
2. Follow steps 1 through 5 under *Lighting Instructions*, page 13.
3. With control knob pressed in, strike match. Hold match to pilot until pilot lights.
4. Keep control knob pressed in for 30 seconds after lighting pilot. After 30 seconds, release control knob. Follow step 8 under *Lighting Instructions*, page 13.
5. Replace front panel.

INSPECTING BURNER

Check pilot flame pattern and burner flame pattern often.

PILOT FLAME PATTERN

Figure 24 shows a correct pilot flame pattern. Figure 25 shows an incorrect pilot flame pattern. The incorrect pilot flame is not touching the thermocouple. This will cause the thermocouple to cool. When the thermocouple cools, the heater will shut down.

If pilot flame pattern is incorrect, as shown in Figure 25

- turn heater off (see *To Turn Off Gas to Appliance*, pages 11, 12 or 14 depending on your model)
- see *Troubleshooting*, pages 16 through 18

Note: The pilot flame on natural gas units will have a slight curve, but flame should be blue and have no yellow or orange color.

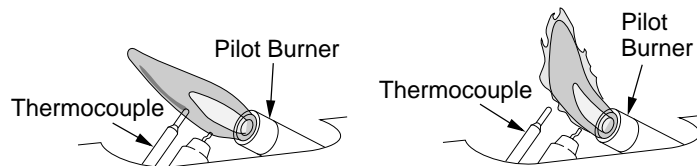

Figure 24 - Correct Pilot Flame Pattern

Figure 25 - Incorrect Pilot Flame Pattern

BURNER FLAME PATTERN BLUE FLAME MODELS

Figure 26 shows a correct burner flame pattern. Figure 27 shows an incorrect burner flame pattern. The incorrect burner flame pattern shows yellow tipping of the flame. It also shows the flame higher than 1/2 the glass panel height.

WARNING: If yellow tipping occurs, your heater could produce increased levels of carbon monoxide. If burner flame pattern shows yellow tipping, proceed with the following instructions.

NOTICE: Do not mistake orange flames with yellow tipping. Dust or other fine particles enter the heater and burn causing brief patches of orange flame.

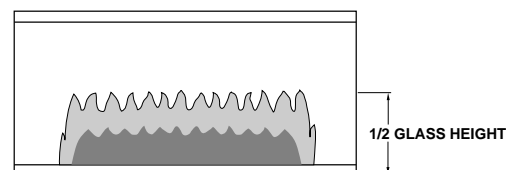

(Models VN600A and VP600A will be lower due to lower input rating)

Figure 26 - Correct Burner Flame Pattern

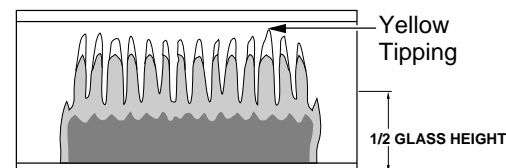

Figure 27 - Incorrect Burner Flame Pattern

INSPECTING BURNER

Continued

If burner flame pattern is incorrect, as shown in Figure 27, page 14

- turn heater off (see *To Turn Off Gas to Appliance*, page 11 or 14 depending on your model)
- see *Troubleshooting*, pages 16 through 18

BURNER FLAME PATTERN INFRARED MODELS

Figure 28 shows a correct burner flame pattern. Figure 29 shows an incorrect burner flame pattern.

If burner flame pattern is incorrect, as shown in Figure 29

- turn heater off (see *To Turn Off Gas to Appliance*, page 12)
- see *Troubleshooting*, pages 16 through 18

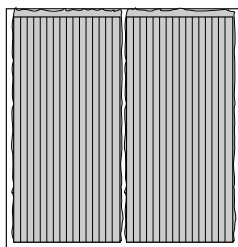

Figure 28 - Correct Burner Flame Pattern (Dual Burner Shown)

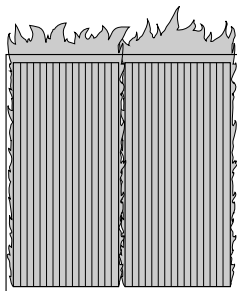

Figure 29 - Incorrect Burner Flame Pattern (Dual Burner Shown)

CLEANING AND MAINTENANCE

WARNING: Turn off heater and let cool before cleaning.

CAUTION: You must keep control areas, burner, and circulating air passageways of heater clean. Inspect these areas of heater before each use. Have heater inspected yearly by a qualified service person. Heater may need more frequent cleaning due to excessive lint from carpeting, bedding material, pet hair, etc.

ODS/PILOT AND BURNER ORIFICE

- Use a vacuum cleaner, pressurized air, or small, soft bristled brush to clean.

CLEANING BURNER PILOT AIR INLET HOLE

The primary air inlet holes allow the proper amount of air to mix with the gas. This provides a clean burning flame. Keep these holes clear of dust, dirt, and lint. Clean these air inlet holes prior to each heating season. Blocked air holes will create soot. We recommend that you clean the unit every three months during operation and have heater inspected yearly by a qualified service person.

We also recommend that you keep the burner tube and pilot assembly clean and free of dust, dirt, lint and pet hair. To clean these parts we recommend using compressed air no greater than 30 PSI. Your local computer store, hardware store, or home center may carry compressed air in a can. You can use a vacuum cleaner in the blow position. If using compressed air in a can, please follow the directions on the can. If you don't follow directions on the can, you could damage the pilot assembly.

1. Shut off the unit, including the pilot. Allow the unit to cool for at least thirty minutes.
2. Inspect burner, pilot for dust and dirt.
3. Blow air through the ports/slots and holes in the burner.

Clean the pilot assembly also. A yellow tip on the pilot flame indicates dust and dirt in the pilot assembly. There is a small pilot air inlet hole about two inches from where the pilot flame comes out of the pilot assembly (see Figure 30). With the unit off, lightly blow air through the air inlet hole. You may blow through a drinking straw if compressed air is not available.

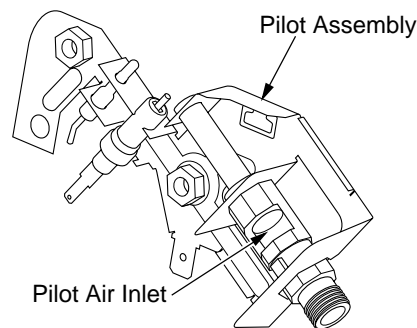

Figure 30 - Pilot Inlet Air (Propane/LP Pilot Shown)

CABINET

Air Passageways

- Use a vacuum cleaner or pressurized air to clean.

Exterior

- Use a soft cloth dampened with a mild soap and water mixture. Wipe the cabinet to remove dust.

TROUBLESHOOTING

Note: For additional help, visit DESA International's technical service web site at www.desatech.com.

Note: All troubleshooting items are listed in order of operation.

⚠ WARNING: Turn off heater and let cool before servicing. Only a qualified service person should service and repair heater.

⚠ CAUTION: Never use a wire, needle, or similar object to clean ODS/pilot. This can damage ODS/pilot unit.

OBSERVED PROBLEM	POSSIBLE CAUSE	REMEDY
When ignitor button is pressed, there is no spark at ODS/pilot	<ol style="list-style-type: none"> 1. Ignitor electrode positioned wrong 2. Ignitor electrode broken 3. Ignitor electrode not connected to ignitor cable 4. Ignitor cable pinched or wet 5. Piezo ignitor nut is loose 6. Broken ignitor cable 7. Bad piezo ignitor 	<ol style="list-style-type: none"> 1. Replace pilot assembly 2. Replace pilot assembly 3. Reconnect ignitor cable 4. Free ignitor cable if pinched by any metal or tubing. Keep ignitor cable dry 5. Tighten nut holding piezo ignitor to heater cabinet. Nut is located inside heater cabinet at top 6. Replace ignitor cable 7. Replace piezo ignitor
When ignitor button is pressed, there is spark at ODS/pilot but no ignition	<ol style="list-style-type: none"> 1. Gas supply turned off or equipment shutoff valve closed 2. Control knob not in PILOT position 3. Control knob not pressed in while in PILOT position 4. Air in gas lines when installed 5. Depleted gas supply (propane/LP only) 6. ODS/pilot is clogged 7. Gas regulator setting is not correct 	<ol style="list-style-type: none"> 1. Turn on gas supply or open equipment shutoff valve 2. Turn control knob to PILOT position 3. Press in control knob while in PILOT position 4. Continue holding down control knob. Repeat igniting operation until air is removed 5. Contact local propane/LP gas company 6. Clean ODS/pilot (see <i>Cleaning and Maintenance</i>, page 15) or replace ODS/pilot assembly 7. Replace gas regulator
ODS/pilot lights but flame goes out when control knob is released	<ol style="list-style-type: none"> 1. Control knob not fully pressed in 2. Control knob not pressed in long enough 3. Equipment shutoff valve not fully open 4. Thermocouple connection loose at control valve 5. Pilot flame not touching thermocouple, which allows thermocouple to cool, causing pilot flame to go out. This problem could be caused by one or both of the following: <ol style="list-style-type: none"> A) Low gas pressure B) Dirty or partially clogged ODS/pilot 6. Thermocouple damaged 7. Control valve damaged 	<ol style="list-style-type: none"> 1. Press in control knob fully 2. After ODS/pilot lights, keep control knob pressed in 30 seconds 3. Fully open equipment shutoff valve 4. Hand tighten until snug, then tighten 1/4 turn more 5. A) Contact local natural or propane/LP gas company B) Clean ODS/pilot (see <i>Cleaning and Maintenance</i>, page 15) or replace ODS/pilot assembly 6. Replace pilot assembly 7. Replace control valve

TROUBLESHOOTING

Continued

OBSERVED PROBLEM	POSSIBLE CAUSE	REMEDY
Burner does not light after ODS/pilot is lit	<ol style="list-style-type: none"> 1. Burner orifice is clogged 2. Inlet gas pressure is too low 	<ol style="list-style-type: none"> 1. Clean burner orifice (see <i>Cleaning and Maintenance</i>, page 15) or replace burner orifice 2. Contact local natural or propane/LP gas company
Delayed ignition of burner	<ol style="list-style-type: none"> 1. Manifold pressure is too low 2. Burner orifice is clogged 	<ol style="list-style-type: none"> 1. Contact local natural or propane/LP gas company 2. Clean burner orifice (see <i>Cleaning and Maintenance</i>, page 15) or replace burner orifice
Burner backfiring during combustion	<ol style="list-style-type: none"> 1. Burner orifice is clogged or damaged 2. Burner damaged 3. Gas regulator defective 	<ol style="list-style-type: none"> 1. Clean burner orifice (see <i>Cleaning and Maintenance</i>, page 15) or replace burner orifice 2. Replace burner 3. Replace gas regulator
Burner plaque(s) does not glow (Infrared models only)	<ol style="list-style-type: none"> 1. Control knob set between locked positions 2. Inlet gas pressure is too low 3. Plaque damaged 	<ol style="list-style-type: none"> 1. Turn control knob until it locks at desired setting 2. Contact local natural or propane/LP gas company 3. Replace burner
Yellow flame during burner combustion	<ol style="list-style-type: none"> 1. Not enough air 2. Inlet gas pressure is too low 3. Gas regulator defective 	<ol style="list-style-type: none"> 1. Check burner for dirt and debris. If found, clean burner (see <i>Cleaning and Maintenance</i>, page 15) 2. Contact local natural or propane/LP gas company 3. Replace gas regulator
Slight smoke or odor during initial operation	<ol style="list-style-type: none"> 1. Residues from manufacturing processes 	<ol style="list-style-type: none"> 1. Problem will stop after a few hours of operation
Heater produces a whistling noise when burner is lit	<ol style="list-style-type: none"> 1. Turning control knob to HIGH position when burner is cold 2. Air in gas line 3. Air passageways on heater blocked 4. Dirty or partially clogged burner orifice 	<ol style="list-style-type: none"> 1. Turn control knob to LOW position and let warm up for a minute 2. Operate burner until air is removed from line. Have gas checked by local natural or propane/LP gas company 3. Observe minimum installation clearances (see Figure 4, page 7) 4. Clean burner (see <i>Cleaning and Maintenance</i>, page 15) or replace burner orifice
Heater produces a clicking/ticking noise just after burner is lit or shut off	<ol style="list-style-type: none"> 1. Metal expanding while heating or contracting while cooling 	<ol style="list-style-type: none"> 1. This is common with most heaters. If noise is excessive, contact qualified service person

TROUBLESHOOTING

Continued

- ⚠ WARNING: If you smell gas**
- Shut off gas supply.
 - Do not try to light any appliance.
 - Do not touch any electrical switch; do not use any phone in your building.
 - Immediately call your gas supplier from a neighbor's phone. Follow the gas supplier's instructions.
 - If you cannot reach your gas supplier, call the fire department.

IMPORTANT: Operating heater where impurities in air exist may create odors. Cleaning supplies, paint, paint remover, cigarette smoke, cements and glues, new carpet or textiles, etc., create fumes. These fumes may mix with combustion air and create odors.

OBSERVED PROBLEM	POSSIBLE CAUSE	REMEDY
White powder residue forming within burner box or on adjacent walls or furniture	1. When heated, vapors from furniture polish, wax, carpet cleaners, etc. may turn into white powder residue	1. Turn heater off when using furniture polish, wax, carpet cleaners, or similar products
Heater produces unwanted odors	1. Heater burning vapors from paint, hair spray, glues, etc. (See IMPORTANT statement above) 2. Low fuel supply (propane/LP only) 3. Gas leak. See Warning statement at top of page	1. Ventilate room. Stop using odor-causing products while heater is running 2. Refill supply tank (propane/LP only) 3. Locate and correct all leaks (see <i>Checking Gas Connections</i> , pages 9 and 10)
Heater shuts off in use (ODS operates)	1. Not enough fresh air is available 2. Low line pressure 3. ODS/pilot is partially clogged	1. Open window and/or door for ventilation 2. Contact local natural or propane/LP gas company 3. Clean ODS/pilot (see <i>Cleaning and Maintenance</i> , page 15)
Gas odor even when control knob is in OFF position	1. Gas leak. See Warning statement at top of page 2. Control valve defective	1. Locate and correct all leaks (see <i>Checking Gas Connections</i> , pages 9 and 10) 2. Replace control valve
Gas odor during combustion	1. Foreign matter between control valve and burner 2. Gas leak. See Warning statement at top of page	1. Take apart gas tubing and remove foreign matter 2. Locate and correct all leaks (see <i>Checking Gas Connections</i> , pages 9 and 10)
Moisture/condensation noticed on windows	1. Not enough combustion/ventilation air	1. Refer to <i>Fresh Air for Combustion and Ventilation</i> requirements (page 4)

SPECIFICATIONS

	VP600BA	VP5D	VP10A	VP10TA	VP1000BTA
Btu (Variable)	4,400/6,000	5,500	5,500/10,000	10,000	5,000/10,000
Type Gas	Propane/LP Only	Propane/LP Only	Propane/LP Only	Propane/LP Only	Propane/LP Only
Ignition	Piezo	Piezo	Piezo	Piezo	Piezo
Pressure Regulator Setting	8" W.C.	8" W.C.	8" W.C.	8.5" W.C.	8" W.C.
Inlet Gas Pressure (inches of water)					
Maximum	14"	14"	14"	14"	14"
Minimum	11"	11"	11"	11"	11"
Dimensions, Inches (H x W x D)					
Heater	20 1/2 x 13 1/2 x 5	20 1/2 x 13 1/2 x 5	20 1/2 x 13 1/2 x 5	21 1/2 x 13 1/2 x 7	21 1/2 x 13 1/2 x 7
Carton	25 x 16 11/16 x 7 1/2	25 x 16 11/16 x 7 1/2	25 x 16 11/16 x 7 1/2	25 1/4 x 16 3/4 x 7 1/2	25 1/4 x 16 3/4 x 7 1/2
Weight (pounds)					
Heater	13.5	13	14	14	
Shipping	19	17	18	18	19
	VN600BA	VN6D	VN10A	VN10TA	VN1000BTA
Btu (Variable)	4,400/6,000	6,000	5,000/10,000	10,000	5,000/10,000
Type Gas	Natural Only	Natural Only	Natural Only	Natural Only	Natural Only
Ignition	Piezo	Piezo	Piezo	Piezo	Piezo
Pressure Regulator Setting	3" W.C.	3" W.C.	3" W.C.	3.5" W.C.	3" W.C.
Inlet Gas Pressure (inches of water)					
Maximum	10.5"	10.5"	10.5"	10.5"	10.5"
Minimum	4"	4"	5"	5"	5"
Dimensions, Inches (H x W x D)					
Heater	20 1/2 x 13 1/2 x 5	20 1/2 x 13 1/2 x 5	20 1/2 x 13 1/2 x 5	21 1/2 x 13 1/2 x 7	20 1/2 x 13 1/2 x 7
Carton	25 x 16 11/16 x 7 1/2	25 x 16 11/16 x 7 1/2	25 x 16 11/16 x 7 1/2	24 3/4 x 16 3/4 x 7 1/2	25 1/4 x 16 3/4 x 7 1/2
Weight (pounds)					
Heater	13.5	13	14	14	
Shipping	17	17	18	18	19

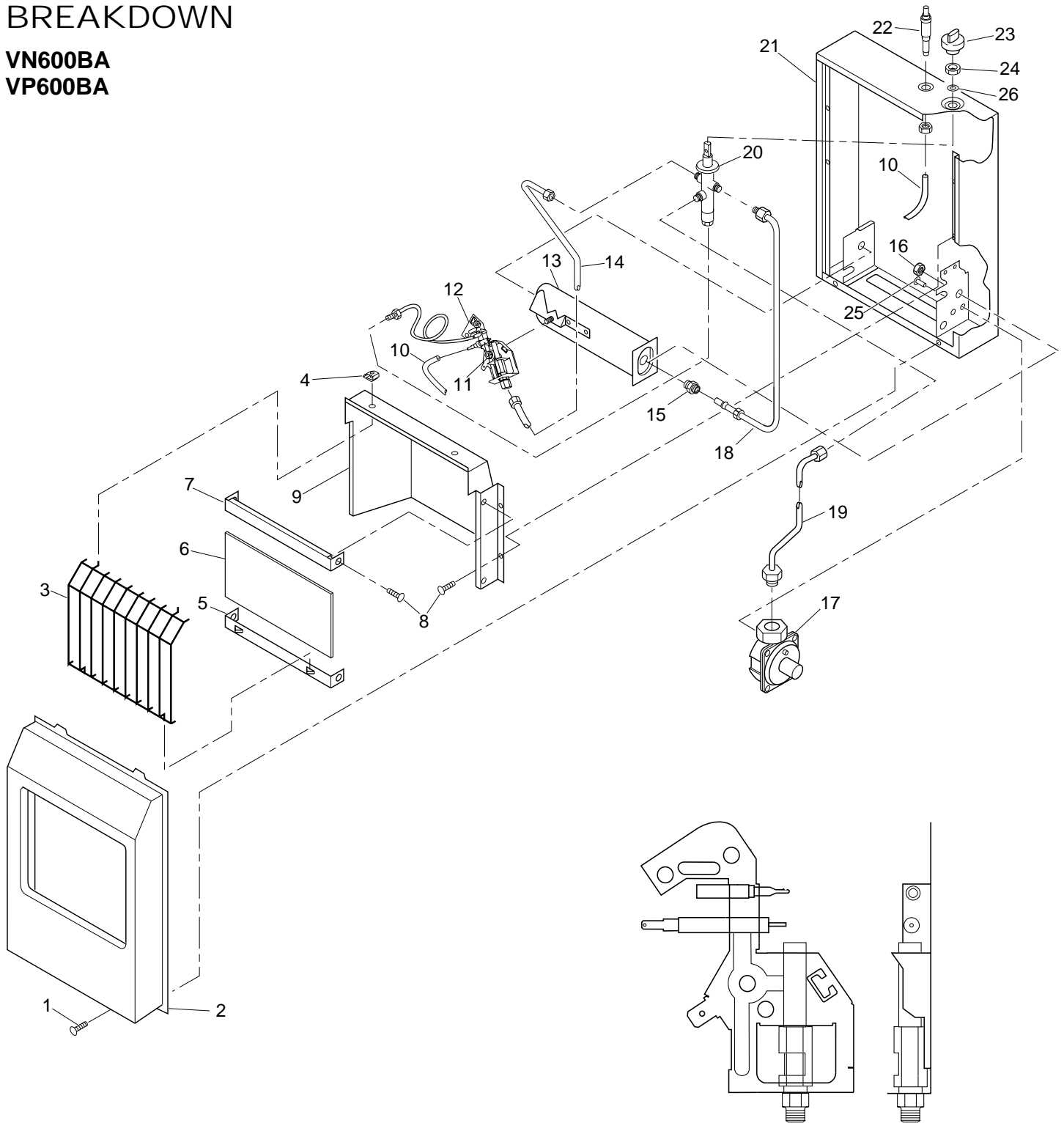
ILLUSTRATED PARTS
BREAKDOWNVN600BA
VP600BA**PILOT**

PARTS LIST

This list contains replaceable parts used in your heater. When ordering parts, follow the instructions listed under *Replacement Parts* on page 30 of this manual.

KEY NO.	PART NUMBER FOR		DESCRIPTION	QTY.
	VP600BA	VN600BA		
1	098304-01	098304-01	Screw, #10 x 3/8"	2
2	099467-07	099467-07	Front Panel	1
3	099318-04	099318-04	Grill Guard	1
4	101108-01	101108-01	Grill Guard Clip	2
5	102017-02	102017-02	Bottom Glass Retainer	1
6	098260-11	098260-11	Glass Panel	1
7	098532-06AA	098532-06AA	Top Glass Retainer	1
8	M11084-38	M11084-38	Screw, #8 x 3/8"	8
9	099317-02	099317-02	Deflector Unit	1
10	098271-09	098271-09	Ignitor Cable	1
11	098249-01	098249-01	Nut, M5	2
12	110803-02***	110803-01***	ODS/Pilot Assembly	1
12-1	110186-01	110186-01	Thermocouple Kit	1
13	104263-02	104263-01	Burner	1
14	099387-05	099387-05	Pilot Tubing	1
15	104259-04	104259-03	Injector, 1 piece	1
16	NJF-8C	NJF-8C	Hex Nut	1
17	099415-18	099415-17	Pressure Regulator	1
18	099462-01	099462-01	Burner Tubing	1
19	099391-02	099391-02	Regulator Tubing	1
20	099413-02	099413-01	Control Valve	1
21	**	**	Cabinet Assembly	
22	097159-04	097159-04	Piezo Ignitor	1
23	099393-02	099393-02	Control Knob	1
24	098508-01	098508-01	Valve Retainer Nut	1
25	098303-02	098303-02	Screw, #6 x 5/16"	2
26	099818-01	099818-01	Internal Tooth Washer	1
PARTS AVAILABLE - NOT SHOWN				
	099395-09	099395-09	Control Position Label	1
	100642-02	100642-02	Assembly, Hardware	1

** Not a field replaceable part.

*** If replacing ODS pilot and your model is pre 2002, your part number will be 099440-03 for natural gas models, 099059-03 for propane/LP models.

ILLUSTRATED PARTS BREAKDOWN

VP10A
VN10A

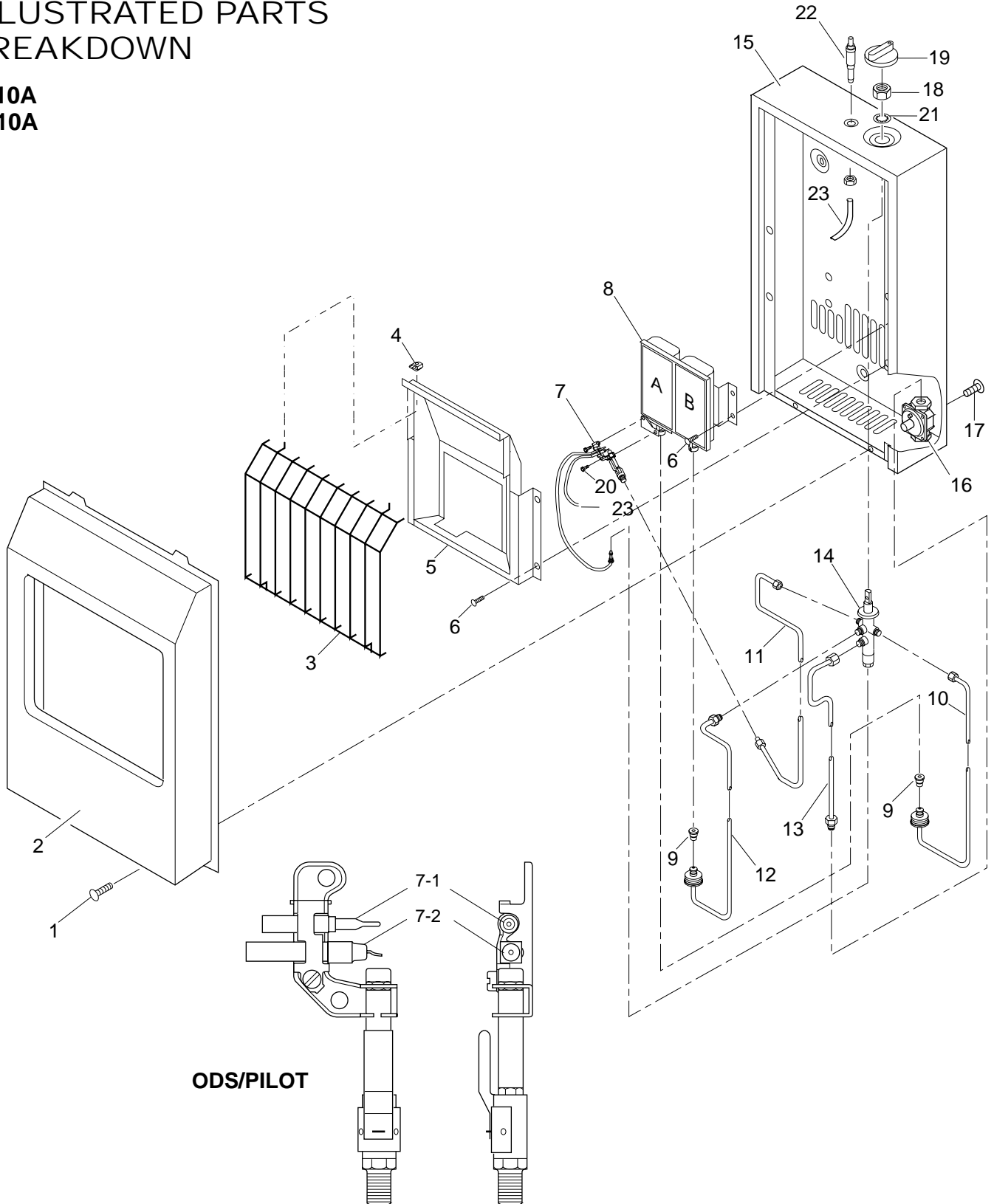

ODS/PILOT

PARTS LIST

This list contains replaceable parts used in your heater. When ordering parts, follow the instructions listed under *Replacement Parts* on page 30 of this manual.

KEY NO.	PART NUMBER		DESCRIPTION	QTY.
	VP10A	VN10A		
1	098304-01	098304-01	Screw, #10 x 3/8"	2
2	**	**	Front Panel Assembly	1
3	099318-03	099318-03	Grill Guard	1
4	101108-01	101108-01	Grill Guard Clip	2
5	099469-02	099469-02	Reflector Assembly	1
6	M15823-37	M15823-37	Screw Hex #8 x 1/4"	10
7	099059-03	503329	ODS/Pilot Assembly	1
7-1	098514-01	098514-01	Thermocouple	1
7-2	098594-01	098594-01	Ignitor Electrode	1
8	099884-02	099884-02	Burner Assembly	1
9	099056-01	099056-06	Injector	2
10	099390-02	099390-02	Tubing - Valve to plaque A	1
11	099387-05	099387-05	Pilot Tubing - Valve to pilot	1
12	099392-01	099392-01	Tubing - Valve to plaque B	1
13	099391-02	099391-02	Tubing - Regulator to valve	1
14	100432-01	100432-01	Control Valve	1
15	**	**	Cabinet Assembly	1
16	099415-18	099415-17	Gas Regulator	1
17	098303-02	098303-02	Screw, #6 x 5/16"	2
18	098508-01	098508-01	Valve Retainer Nut	1
19	099393-02	099393-02	Control Knob	1
20	M11084-26	M11084-26	Screw, #10 x 3/8"	2
21	099818-01	099818-01	Internal Tooth Washer	1
22	097159-04	097159-04	Piezo Ignitor	1
23	098271-03	098271-03	Ignitor Cable	1
PARTS AVAILABLE - NOT SHOWN				
	100642-02	100642-02	Assembly, Hardware	1

** Not a field replaceable part.

ILLUSTRATED PARTS BREAKDOWN

**VP10TA
VN10TA**

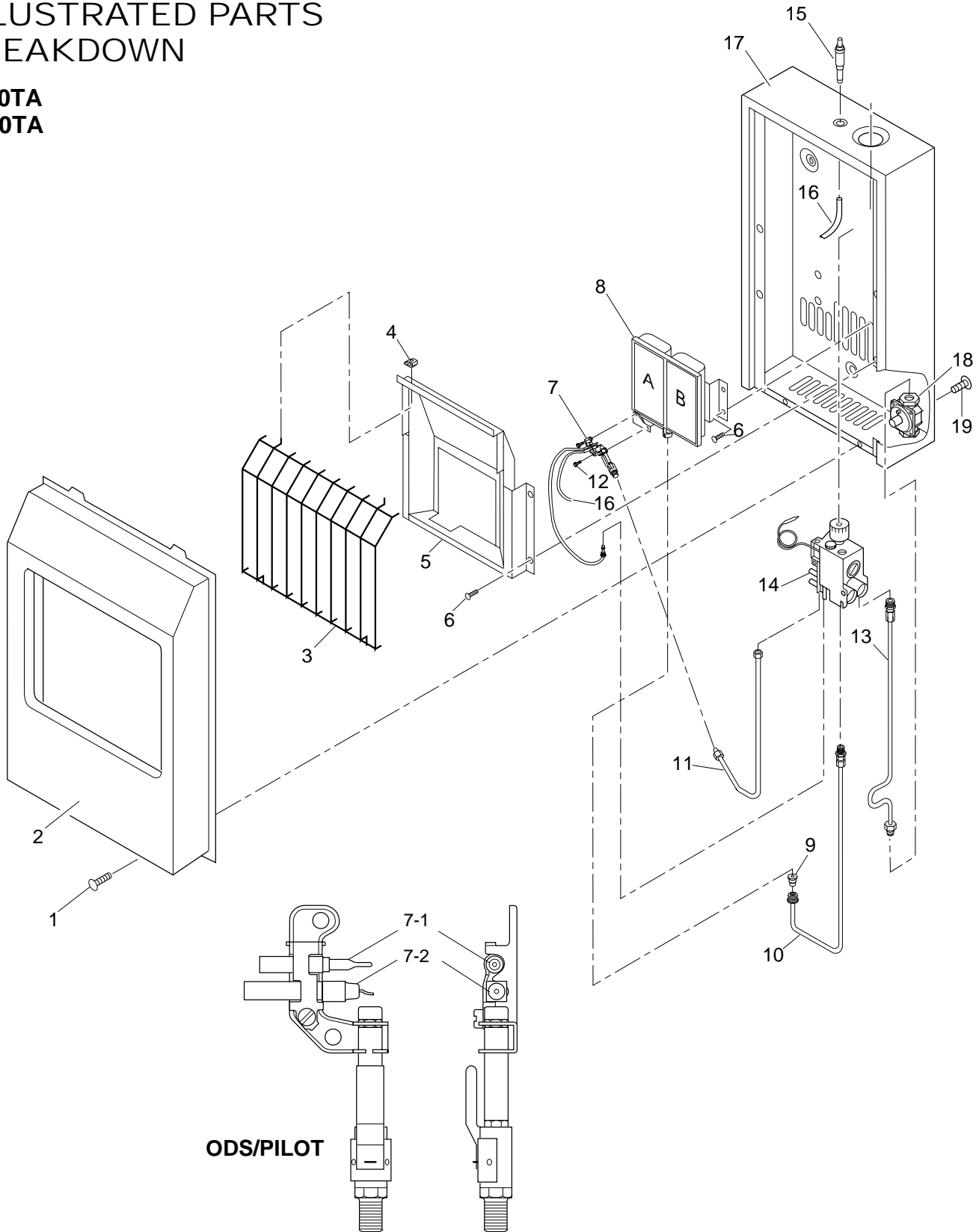

PARTS LIST

This list contains replaceable parts used in your heater. When ordering parts, follow the instructions listed under *Replacement Parts* on page 30 of this manual.

KEY NO.	PART NUMBER		DESCRIPTION	QTY.
	VP10TA	VN10TA		
1	098304-01	098304-01	Screw, #10 x 3/8"	2
2	**	**	Front Panel Assembly	1
3	099318-03	099318-03	Grill Guard	1
4	101108-01	101108-01	Grill Guard Clip	2
5	099275-01	099275-01	Reflector Assembly	1
6	M15823-37	M15823-37	Screw Hex #8 x 1/4"	10
7	099059-03	503329	ODS/Pilot Assembly	1
7-1	098514-01	098514-01	Thermocouple	1
7-2	098594-01	098594-01	Ignitor Electrode	1
8	099884-03	099884-03	Burner Assembly	1
9	099056-25	099056-24	Injector	2
10	104087-01	104087-01	Tubing - Burner	1
11	099387-11	099387-11	Pilot Tubing - Valve to pilot	1
12	M11084-26	M11084-26	Screw, #10 x 3/8"	2
13	104084-01	104084-01	Tubing - Inlet	1
14	098522-16	098522-16	Control Valve	1
15	097159-04	097159-04	Piezo Ignitor	1
16	098271-03	098271-03	Ignitor Cable	1
17	**	**	Cabinet Assembly	1
18	099415-18	099415-12	Gas Regulator	1
19	098303-02	098303-02	Screw, #6 x 5/16"	2
PARTS AVAILABLE - NOT SHOWN				
	100642-02	100642-02	Assembly, Hardware	1

** Not a field replaceable part.

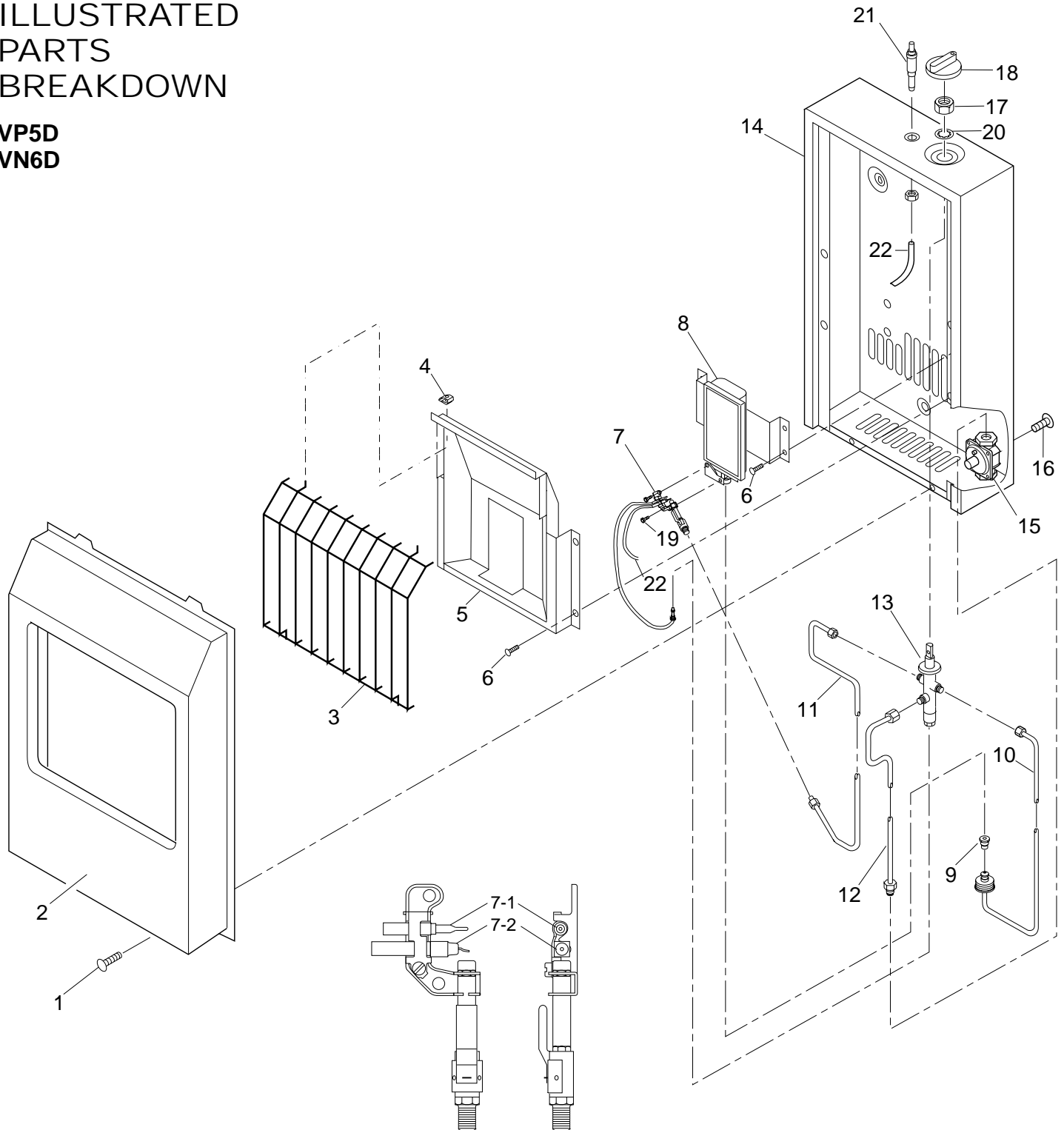
ILLUSTRATED
PARTS
BREAKDOWNVP5D
VN6D

ODS/PILOT

PARTS LIST

This list contains replaceable parts used in your heater. When ordering parts, follow the instructions listed under *Replacement Parts* on page 30 of this manual.

KEY NO.	PART NUMBER		DESCRIPTION	QTY.
	VP5D	VN6D		
1	098304-01	098304-01	Screw, #10 x 3/8"	2
2	**	**	Front Panel Assembly	1
3	099318-03	099318-03	Grill Guard	1
4	101108-01	101108-01	Grill Guard Clip	2
5	099469-01	099469-02	Reflector Assembly	1
6	M15823-37	M15823-37	Screw Hex #8 x 1/4"	9
7	099059-03	503329	ODS/Pilot Assembly	1
7-1	098514-01	098514-01	Thermocouple	1
7-2	098594-01	098594-01	Ignitor Electrode	1
8	099884-01	099884-01	Burner Assembly	1
9	099056-04	099056-01	Injector	1
10	099390-01	099390-01	Tubing - Valve to burner	1
11	099387-05	099387-05	Pilot Tubing - Valve to pilot	1
12	099391-02	099391-02	Tubing - Regulator to valve	1
13	100829-01	100829-01	Control Valve	1
14	**	**	Cabinet Assembly	1
15	099415-18	099415-17	Gas Regulator	1
16	098303-02	098303-02	Screw, #6 x 5/16"	2
17	098508-01	098508-01	Valve Retainer Nut	1
18	099393-02	099393-02	Control Knob	1
19	M11084-26	M11084-26	Screw, #10 x 3/8"	2
20	099818-01	099818-01	Internal Tooth Washer	1
21	097159-04	097159-04	Piezo Ignitor	1
22	098271-03	098271-03	Ignitor Cable	1
PARTS AVAILABLE - NOT SHOWN				
	100642-02	100642-02	Assembly, Hardware	1

** Not a field replaceable part.

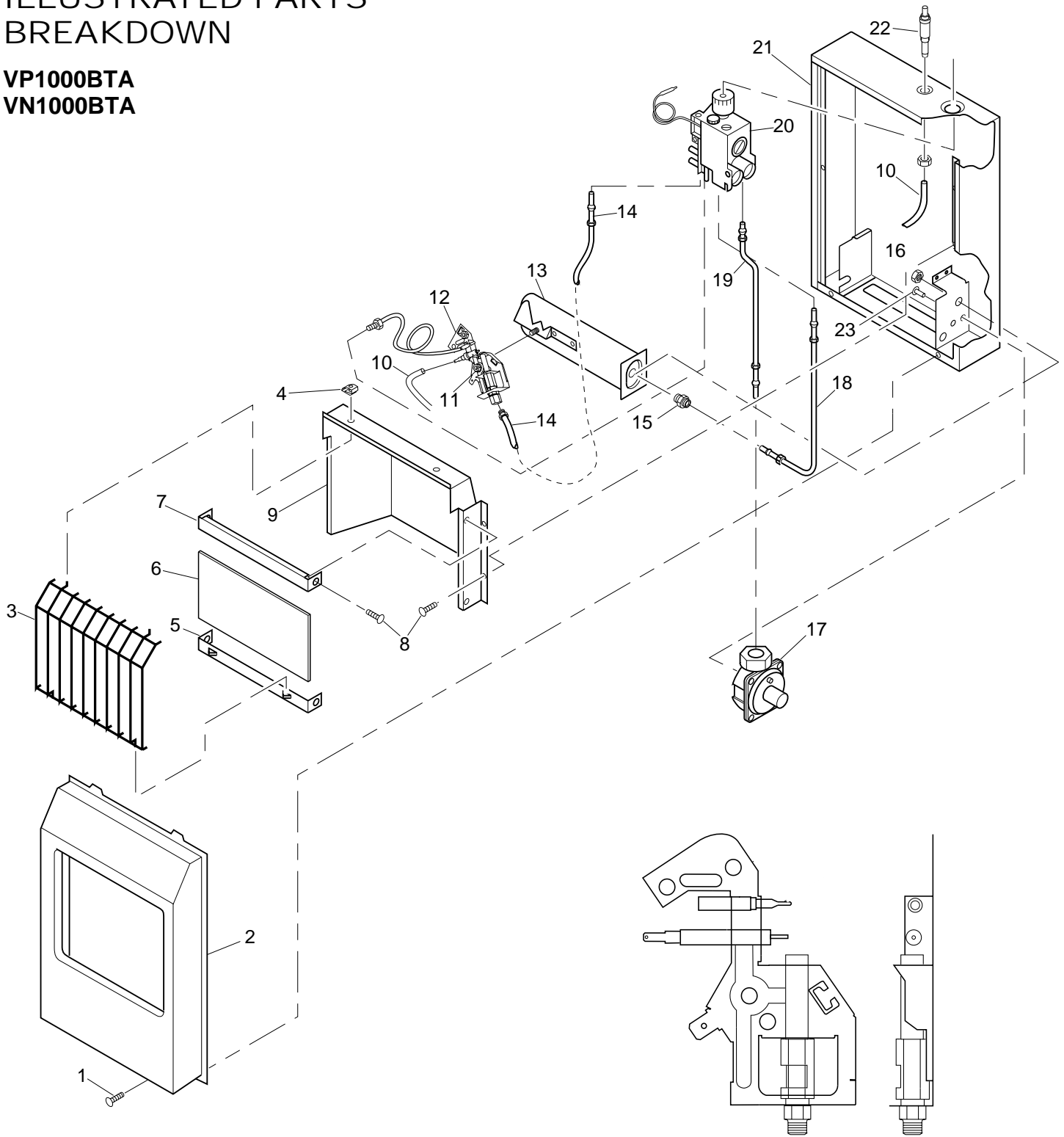
ILLUSTRATED PARTS
BREAKDOWNVP1000BTA
VN1000BTA**PILOT**

PARTS LIST

This list contains replaceable parts used in your heater. When ordering parts, follow the instructions listed under *Replacement Parts* on page 30 of this manual.

KEY NO.	PART NUMBER		DESCRIPTION	QTY.
	VP1000BTA	VN1000BTA		
1	098304-01	098304-01	Screw, #10 x 3/8"	2
2	**	**	Front Panel Assembly	1
3	099318-04	099318-04	Grill Guard	1
4	101108-01	101108-01	Grill Guard Clip	2
5	102017-02	102017-02	Bottom Glass Retainer	1
6	098260-11	098260-11	Glass Panel	1
7	099319-02	099319-02	Top Glass Retainer	1
8	M11084-38	M11084-38	Screw, #8 x 3/8"	8
9	099317-02	099317-02	Deflector Unit	1
10	098271-09	098271-09	Ignitor Cable	1
11	098249-01	098249-01	Nut, M5	2
12	110803-02***	110803-01***	ODS/Pilot Assembly	1
12-1	110186-01	110186-01	Thermocouple Kit	1
13	104263-01	104263-01	Burner	1
14	099387-11	099387-11	Pilot Tubing	1
15	104259-06	104259-05	Injector, 1 Piece	1
16	NJF 8C	NJF 8C	Hex Nut	1
17	099415-18	099415-17	Pressure Regulator	1
18	104261-01	104261-01	Burner Tubing	1
19	104264-01	104264-01	Regulator Tubing	1
20	098522-18	098522-11	Thermostat Gas Valve	1
21	**	**	Cabinet Assembly	1
22	097159-04	097159-04	Piezo Ignitor	1
23	098303-02	098303-02	Screw, #6 x 5/16"	2
PARTS AVAILABLE - NOT SHOWN				
	100642-02	100642-02	Assembly, Hardware	1

** Not a field replaceable part.

*** If replacing ODS pilot and your model is pre 2002, your part number will be 100701-03 for natural gas models, 099059-03 for propane/LP models.

REPLACEMENT PARTS

Note: Use only original replacement parts. This will protect your warranty coverage for parts replaced under warranty.

PARTS UNDER WARRANTY

Contact authorized dealers of this product. If they can't supply original replacement part(s), call DESA International's Technical Service Department at 1-866-672-6040.

When calling DESA International, have ready

- your name
- your address
- model and serial numbers of your heater
- how heater was malfunctioning
- type of gas used (propane/LP or natural gas)
- purchase date

Usually, we will ask you to return the part to the factory.

PARTS NOT UNDER WARRANTY

Contact authorized dealers of this product. If they can't supply original replacement part(s), either contact your nearest Parts Central (see page 33) or call DESA International at 1-866-672-6040 for referral information.

When calling DESA International, have ready

- model number of your heater
- the replacement part number

SERVICE HINTS

When Gas Pressure Is Too Low

- pilot will not stay lit
- burner will have delayed ignition
- heater will not produce specified heat
- for propane/LP unit, propane/LP gas supply may be low

You may feel your gas pressure is too low. If so, contact your local gas supplier.

TECHNICAL SERVICE

You may have further questions about installation, operation, or troubleshooting. If so, contact DESA International's Technical Service Department at 1-866-672-6040. When calling please have your model and serial numbers of your heater ready.

You can also visit DESA International's technical service web site at www.desatech.com.

SERVICE PUBLICATIONS

You can purchase a service manual from the address listed on the back page of this manual. Send a check for \$5.00 payable to DESA International.

ACCESSORY

Purchase these heater accessories from your local dealer. If they cannot supply this accessory, either contact your nearest Parts Central (see page 33) or call DESA International at 1-866-672-6040 for referral information. You can also write to the address listed on the back page of this manual.

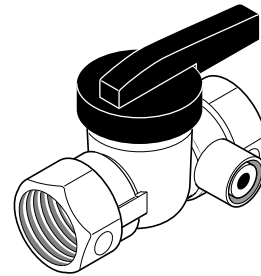

EQUIPMENT SHUTOFF VALVE - GA5010

For all models. Equipment shutoff valve with 1/8" NPT tap.

OWNER'S REGISTRATION FORM

In order to provide better customer service for this and future purchases, we recommend that you register your product with us. You can register online at www.desatech.com. If access to our website is not available to you, please complete this Owner's Registration Form and mail to the address on the back of this owner's manual. Please provide the following product information:

Brand: _____ (Comfort Glow, Vanguard, etc.)
 Model: _____ (EFP33PR, VTGH33NR, etc.)
 Date Purchased: _____ *Note: Keep receipt for warranty verification.*
 Serial Number: _____ 7 or 9 digit number located on product or identification tag.
 First Name: _____ Last Name: _____
 Address: _____
 City: _____ State: _____ Zip: _____ Country: _____
 Home Phone: _____
 E-Mail: _____

Please answer the following questions to register your product with DESA International:

1. Where will the product be used?
 Living/Family Room Office/Warehouse Utility Shed/Outbuilding Garage Bedroom Bathroom Other
2. If you bought this product yourself, did you plan to purchase this type of product before going into the store? Yes No
3. Who selected the product? Male Female Both
4. What is the population of your area? Under 10,000 10,000 to 25,000 25,000 to 50,000 50,000 to 100,000
 100,000 to 250,000 Over 250,000
5. What is your primary source of heat? Propane (LP Gas) Fuel Oil Wood Natural Gas Electric Other
6. How was the product installed? Professional Installer Self Other
7. Cost of product excluding sales tax? \$ _____
8. Cost to install product? \$ _____
9. Type of store where product was purchased? Hardware Propane Dealer Natural Gas/Utility Co. Home Center/Builder's Supply
 Fireplace or Hearth Shop Farm Store Other
10. What motivated you to buy this product? Sudden Cold Weather Replace Older Model D.I.Y. Home Project
 Emergency Back-Up Heat Heater was on Sale Energy Savings/High Efficiency Construction Project Other
11. How did you learn about this product brand? Advertising Relative or Friend Store Display Other _____
12. Level of Education of Purchaser: Some High School Completed High School Completed College Completed Graduate School
13. Age of Purchaser: Under 20 20 - 29 30 - 39 40 - 49 50 - 59 60 or Over
14. Buyer's total annual household income: Under \$15,000 \$15,000 to \$19,999 \$20,000 to \$34,999 \$35,000 to \$49,999
 \$50,000 to \$74,999 \$75,000 to \$99,999 \$100,000 and Over
15. Store where product was purchased:
 Name: _____
 City: _____ State: _____

16. In choosing this product, how important were the following:

	Not Important	Somewhat Important	Very Important
Availability	<input type="radio"/>	<input type="radio"/>	<input type="radio"/>
Price	<input type="radio"/>	<input type="radio"/>	<input type="radio"/>
Brand Name	<input type="radio"/>	<input type="radio"/>	<input type="radio"/>
Overall Quality	<input type="radio"/>	<input type="radio"/>	<input type="radio"/>
Heat Output	<input type="radio"/>	<input type="radio"/>	<input type="radio"/>
Made in USA	<input type="radio"/>	<input type="radio"/>	<input type="radio"/>
Warranty	<input type="radio"/>	<input type="radio"/>	<input type="radio"/>
Local Service	<input type="radio"/>	<input type="radio"/>	<input type="radio"/>
Value for Price	<input type="radio"/>	<input type="radio"/>	<input type="radio"/>
Prior Brand Experience	<input type="radio"/>	<input type="radio"/>	<input type="radio"/>
Controls Location	<input type="radio"/>	<input type="radio"/>	<input type="radio"/>
Thermostat, Remote, or Manual Operation	<input type="radio"/>	<input type="radio"/>	<input type="radio"/>
Ease of Operation	<input type="radio"/>	<input type="radio"/>	<input type="radio"/>
Special Features	<input type="radio"/>	<input type="radio"/>	<input type="radio"/>
Salesperson's Recommendation	<input type="radio"/>	<input type="radio"/>	<input type="radio"/>
Friend/Relative's Recommendation	<input type="radio"/>	<input type="radio"/>	<input type="radio"/>
Portability	<input type="radio"/>	<input type="radio"/>	<input type="radio"/>
Quiet Operation	<input type="radio"/>	<input type="radio"/>	<input type="radio"/>

TAPE

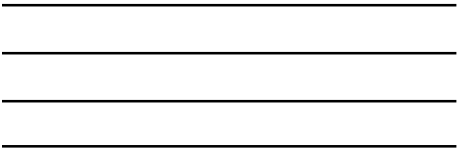

Postage
Required

DESATM
INTERNATIONAL
2701 Industrial Drive
P.O. Box 90004
Bowling Green, KY 42102-9004

TAPE

PARTS CENTRALS

These Parts Centrals are privately owned businesses. They have agreed to support our customer's needs by providing original replacement parts and accessories.

Baltimore Electric

1348 Dixwell Avenue
Hamden, CT 06514-0322
1-800-397-7553
203-248-7553
Parts Department

Portable Heater Parts

342 N. County Rd. 400 East
Valparaiso, IN 46383-9704
All States
219-462-7441
1-888-619-7060
sales@portableheaterparts.com
techservice@portableheaterparts.com

FBD

1349 Adams Street
Bowling Green, KY 42103-3414
270-846-1199
1-800-654-8534
Fax: 1-800-846-0090
franktalk@aol.com

Master Parts Dist.

1251 Mound Ave. NW
Grand Rapids, MI 49504-2672
616-791-0505
1-800-446-1446
Fax: 616-791-8270
www.nbmc.com

Washer Equipment Co.

1715 Main Street
Kansas City, MO 64108-2195
KS, MO, AR
816-842-3911
www.washerparts.com

East Coast Energy Products

707 Broadway
W. Long Branch, NJ 07764-1542
732-870-8809
1-800-755-8809
www.njplaza.com/ecep

Dayton Hardware

P.O. Box 275
North Dayton Station
Dayton, OH 45404-0275
All States
937-258-3721
OH 1-800-762-3426

Halco Enterprises

208 Carter Drive, Unit 21
West Chester, PA 19382-4500
610-430-7717
1-800-368-0803
www.halcoenterprises.com

Laportes Parts & Service

2444 N. 5th Street
Hartsville, SC 29550-7704
843-332-0191
Parts Department

Cans Unlimited, Inc.

P.O. Box 645
Taylor, SC 29687-0013
All States
803-879-3009
1-800-845-5301
cuissales@aol.com

WARRANTY INFORMATION

KEEP THIS WARRANTY

Model _____
Serial No. _____
Date Purchased _____

Always specify model and serial numbers when communicating with the factory.

We reserve the right to amend these specifications at any time without notice. The only warranty applicable is our standard written warranty. We make no other warranty, expressed or implied.

LIMITED WARRANTY DESA INTERNATIONAL VENT-FREE RESIDENTIAL GAS HEATERS

DESA International warrants this product to be free from defects in materials and components for four (4) years and five (5) years on stainless steel burners from the date of first purchase, provided that the product has been properly installed, operated and maintained in accordance with all applicable instructions. To make a claim under this warranty the Bill of Sale or cancelled check must be presented.

This warranty is extended only to the original retail purchaser. This warranty covers the cost of part(s) required to restore this heater to proper operating condition and an allowance for labor when provided by a DESA Authorized Service Center. Warranty part(s) MUST be obtained through authorized dealers of this product and/or DESA International who will provide original factory replacement parts. Failure to use original factory replacement parts voids this warranty. The heater MUST be installed by a qualified installer in accordance with all local codes and instructions furnished with the unit.

This warranty does not apply to parts that are not in original condition because of normal wear and tear, or parts that fail or become damaged as a result of misuse, accidents, lack of proper maintenance or defects caused by improper installation. Travel, diagnostic cost, labor, transportation and any and all such other costs related to repairing a defective heater will be the responsibility of the owner.

TO THE FULL EXTENT ALLOWED BY THE LAW OF THE JURISDICTION THAT GOVERNS THE SALE OF THE PRODUCT; THIS EXPRESS WARRANTY EXCLUDES ANY AND ALL OTHER EXPRESSED WARRANTIES AND LIMITS THE DURATION OF ANY AND ALL IMPLIED WARRANTIES, INCLUDING WARRANTIES OF MERCHANTABILITY AND FITNESS FOR A PARTICULAR PURPOSE TO FOUR (4) YEARS ON ALL COMPONENTS AND FIVE (5) YEARS ON STAINLESS STEEL BURNERS FROM THE DATE OF FIRST PURCHASE; AND DESA INTERNATIONAL'S LIABILITY IS HEREBY LIMITED TO THE PURCHASE PRICE OF THE PRODUCT AND DESA INTERNATIONAL SHALL NOT BE LIABLE FOR ANY OTHER DAMAGES WHATSOEVER INCLUDING INDIRECT, INCIDENTAL OR CONSEQUENTIAL DAMAGES.

Some states do not allow a limitation on how long an implied warranty lasts or an exclusion or limitation of incidental or consequential damages, so the above limitation on implied warranties, or exclusion or limitation on damages may not apply to you.

This warranty gives you specific legal rights, and you may also have other rights that vary from state to state.

For information about this warranty write:



2701 Industrial Drive
P.O. Box 90004
Bowling Green, KY 42102-9004
www.desatech.com



110720 01

NOT A UPC

110720-01
Rev. C
01/03